

HONDA GENERATOR

EM1600

OWNER'S MANUAL

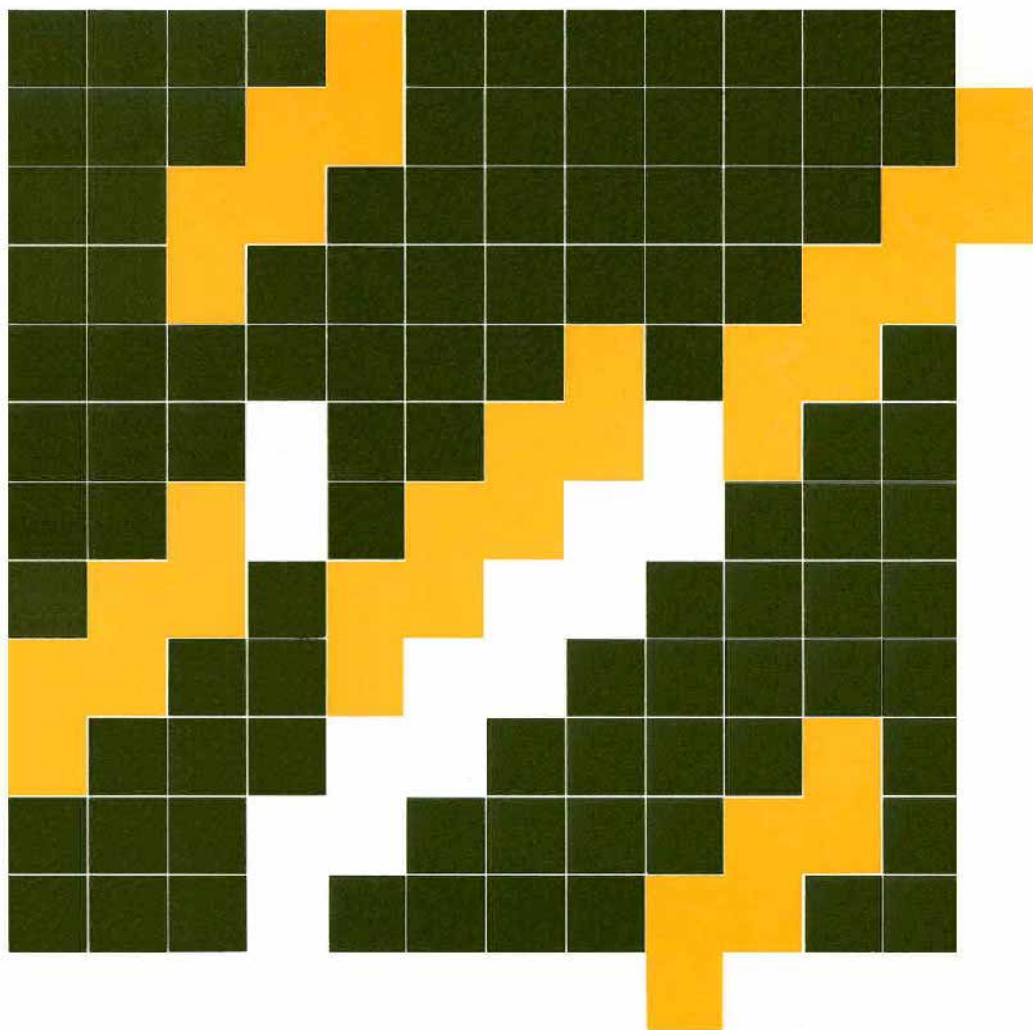

Thank you for purchasing a Honda generator.

This manual covers operation and maintenance of the EM1600 generator. All information in this publication is based on the latest product information available at the time of approval for printing.

Honda Motor Co., Ltd. reserves the right to make changes at any time without notice and without incurring any obligation.

No part of this publication may be reproduced without written permission.

This manual should be considered a permanent part of the generator and remain with the generator when sold.

Pay special attention to statements preceded by the following words:

WARNING Indicates a strong possibility of severe personal injury or loss of life if instructions are not followed.

CAUTION: Indicates a possibility of personal injury or equipment damage if instructions are not followed.

NOTE: Gives helpful information.

If a problem should arise, or if you have any questions about the generator, consult an authorized Honda dealer.

WARNING The Honda generator is designed to give safe and dependable service if operated according to instructions. Read and understand the Owner's Manual before operating the generator. Failure to do so could result in personal injury or equipment damage.

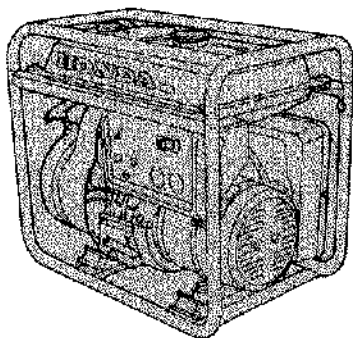

CONTENTS

CONTENTS

1. GENERATOR SAFETY	1
2. COMPONENT IDENTIFICATION	2
3. PRE-OPERATION CHECK	4
4. STARTING THE ENGINE	8
5. GENERATOR USE	11
6. STOPPING THE ENGINE	14
7. MAINTENANCE	16
8. TRANSPORTING/STORAGE	25
9. TROUBLESHOOTING	27
10. SPECIFICATIONS	30
11. WIRING DIAGRAM	31

1. GENERATOR SAFETY

WARNING

To ensure safe operation --

- Place the generator at least 1 m (3 ft) away from buildings or other equipment when operating the generator.
- Operate the generator on a level surface.
If the generator is tilted, fuel spillage may result.
- Exhaust gas contains poisonous carbon monoxide.
Never run the generator in an enclosed area.
Be sure to provide adequate ventilation.
- Know how to stop the generator quickly and understand operation of all the controls. Never permit anyone to operate the generator without proper instructions.
- Keep children and pets away from the generator when it is in operation.
- Keep away from rotating parts while the generator is running.
- The generator is a potential source of electrical shocks when misused; do not operate with wet hands.
Do not operate the generator in rain or snow and do not let it get wet.

2. COMPONENT IDENTIFICATION

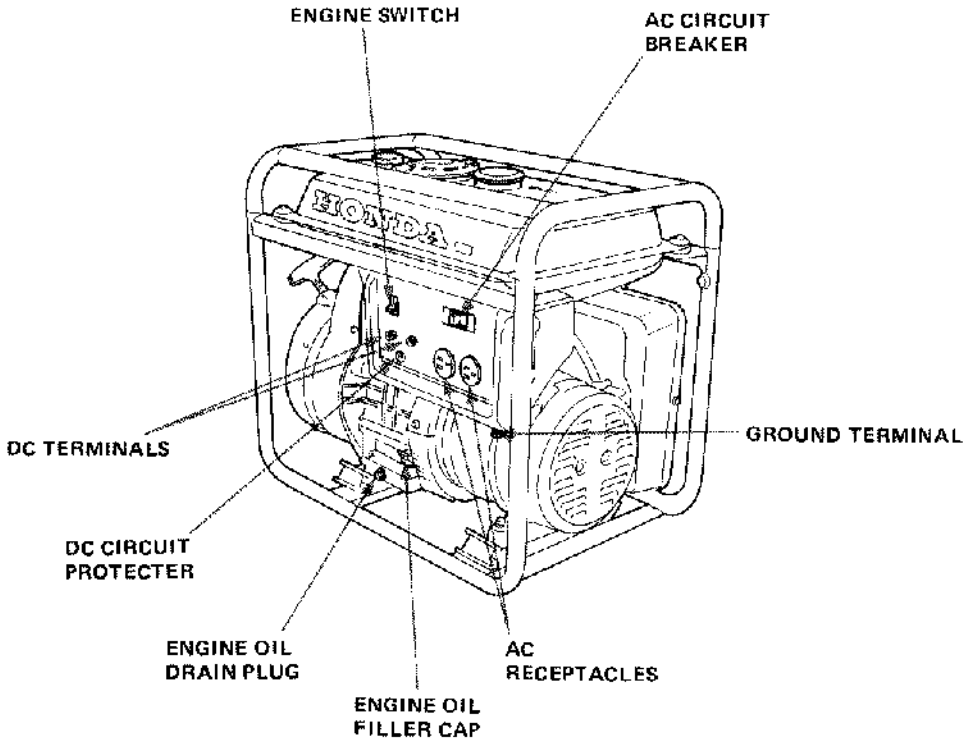

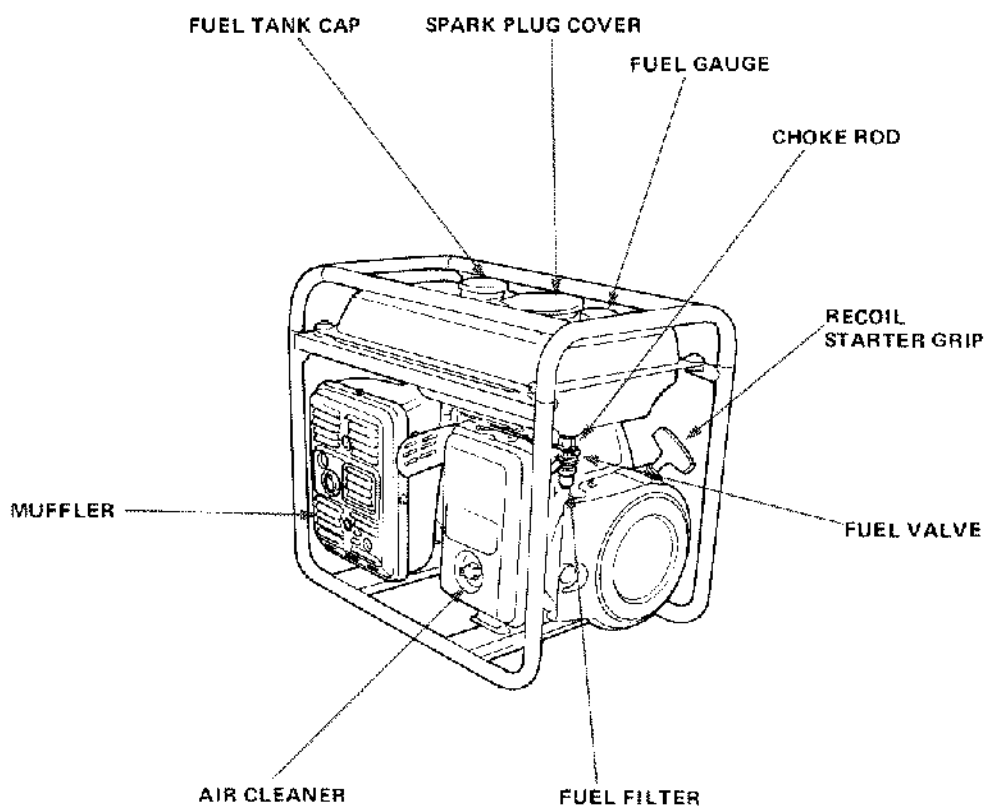

3. PRE-OPERATION CHECK

CAUTION: Be sure to check the generator on a level surface with the engine stopped.

1. Check the engine oil level.

CAUTION: Engine oil is major factor affecting engine performance and service life. Non-detergent or vegetable oils are not recommended.

Use Honda 4-stroke oil, or an equivalent high detergent, premium quality motor oil certified to meet or exceed U.S. automobile manufacturer's requirements for Service Classification SE or SF. (Motor oils classified SE or SF will show this designation on the container.)

SAE 10W-40 is recommended for general, all-temperature use. If single viscosity oil is used, select the appropriate viscosity for the average temperature in your area.

Remove the oil filler cap and check the oil level.

If the level is low, fill to the top of the oil filler neck with the recommended oil.

CAUTION: Running the engine with insufficient oil can cause serious engine damage.

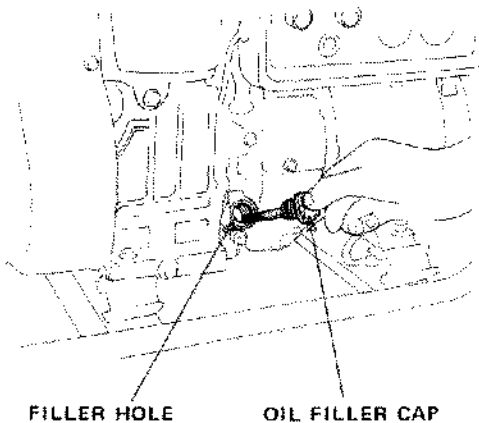

SAE	°C	°F	
40	30°	86°	SAE 10W-30 or 10W-40
30	15°	59°	
20 20W	0°	32°	
10W			

NOTE: When the oil runs lower than the specified level during operation, the engine switch automatically turns off through an oil alert system to protect the engine from overheating.

If this occurs, add oil to the top of the filler hole neck, then turn the switch on and restart the engine according to the instructions.

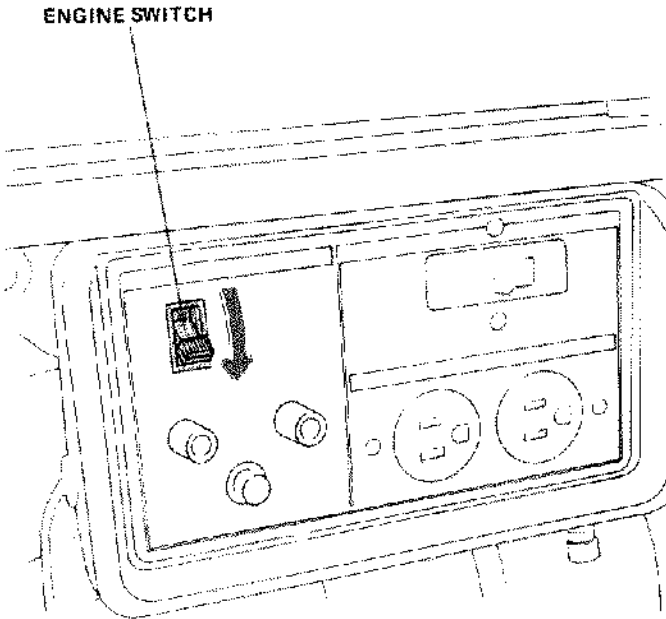

2. Check the fuel level.

Use automotive gasoline with a research octane of 91 or higher or a pump octane $\left(\frac{R + M}{2}\right)$ of 86 or higher.

Fill to the "LEVEL" mark in the filler screen.

Never use an oil/gasoline mixture or dirty gasoline. Avoid getting dirt, dust or water in the fuel tank.

CAUTION: Gasoline substitutes are not recommended; they may be harmful to the fuel system components.

Warning

- Gasoline is extremely flammable and explosive under certain conditions. Refuel in a well ventilated area with the engine stopped.
- Do not smoke or allow flames or sparks in the area where the generator is refueled or where gasoline is stored.
- Do not overfill the tank and make sure the filler cap is securely closed after refueling.
- Be careful not to spill fuel when refueling. Fuel vapor or spilled fuel may ignite. If any fuel is spilled, make sure the area is dry before starting the engine.

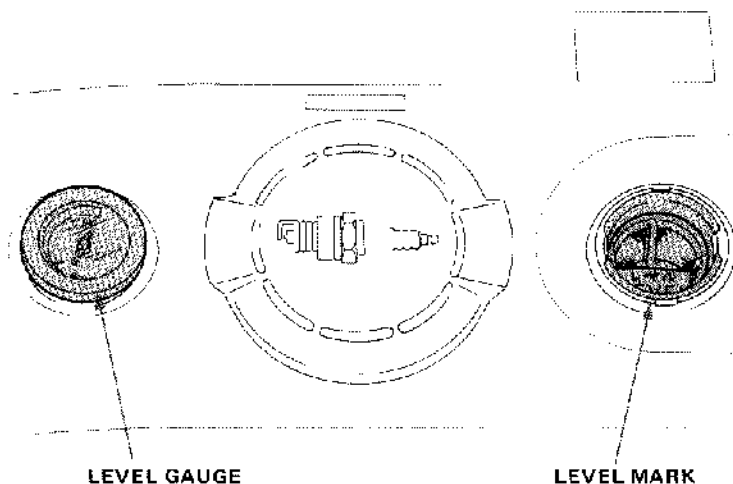

-
3. Make sure that the AC circuit breaker is OFF and that nothing is connected to the DC terminals.

The generator may be hard to start if a load is connected.

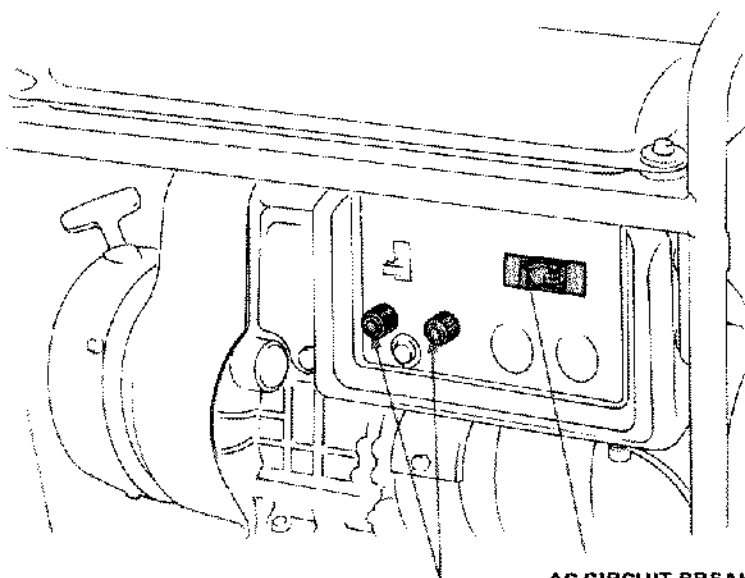

AC CIRCUIT BREAKER

DC TERMINALS

4. STARTING THE ENGINE

1. Turn the fuel valve on.

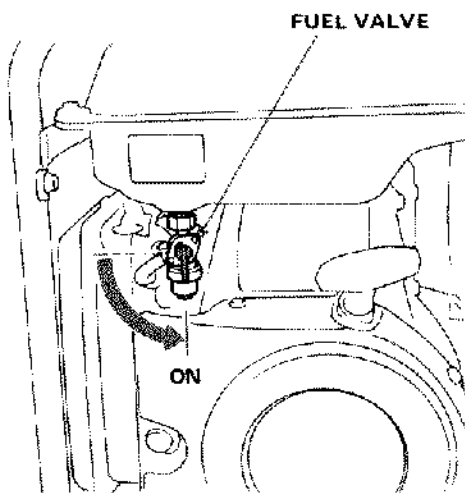

2. Turn the engine switch on.

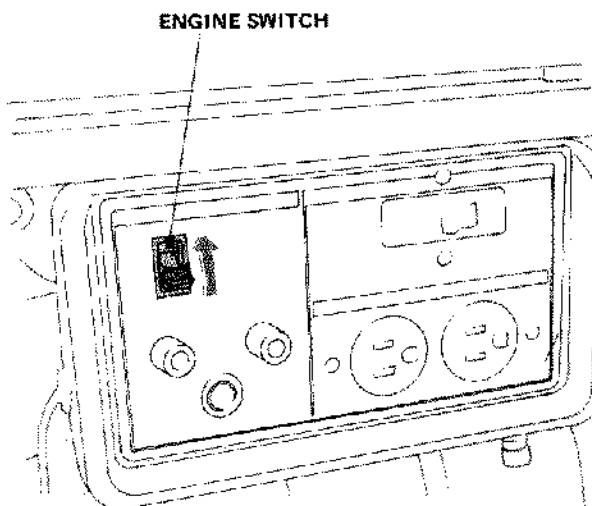

3. Pull the choke rod to **CLOSE**.

NOTE: Do not use the choke when the engine is warm or the air temperature is high.

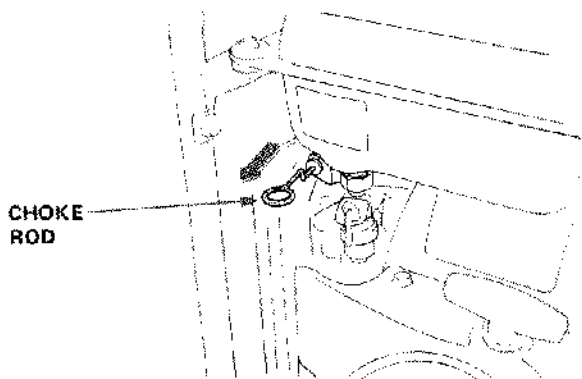

4. Pull the starter grip until compression is felt, then pull briskly.

NOTE: Do not allow the starter grip to snap back. Return it slowly by hand.

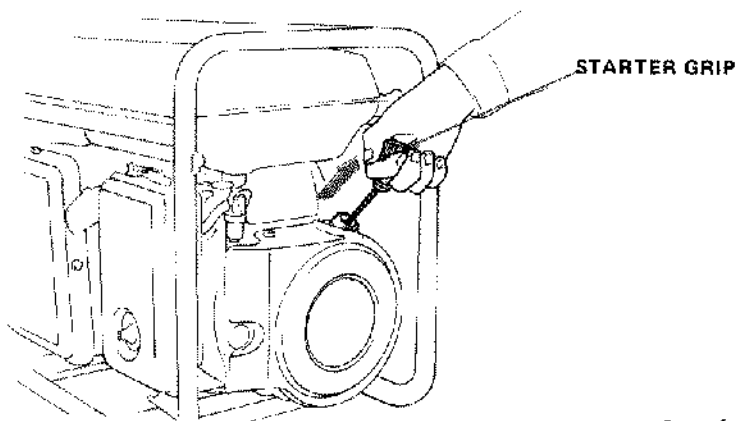

Cont'd

5. Push the choke rod to OPEN as the engine warms up.

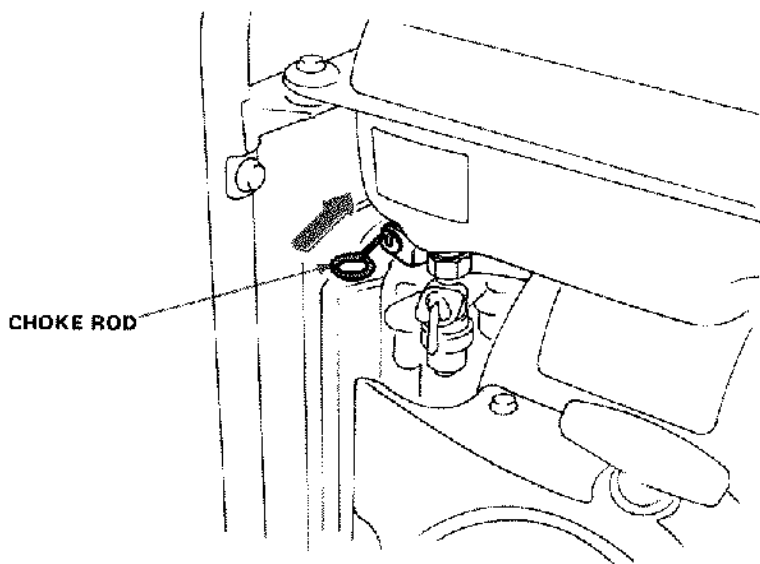

5. GENERATOR USE

Warning To prevent electrical shock from faulty appliances, the generator should be grounded. Connect a length of heavy wire between the ground terminal and the ground source.

CAUTION:

- **Limit operation requiring maximum power (1.6 kVA) to 30 minutes. For continuous operation, do not exceed the rated power of 1.4 kVA. In either case, the total wattage of all appliances connected must be considered.**
- **Do not exceed the current limit specified for any one receptacle.**
- **Do not connect the generator to a household circuit. This could cause the damage to the generator or to electrical appliances in the house.**

Cont'd

AC applications

1. Switch on the AC Circuit Breaker.

NOTE: The breaker will automatically switch off when the circuit is overloaded.

2. Plug in the appliance; use three-pronged plugs.

NOTE: This generator is equipped with an AVR (Automatic Voltage Regulator) for stable voltage supply.

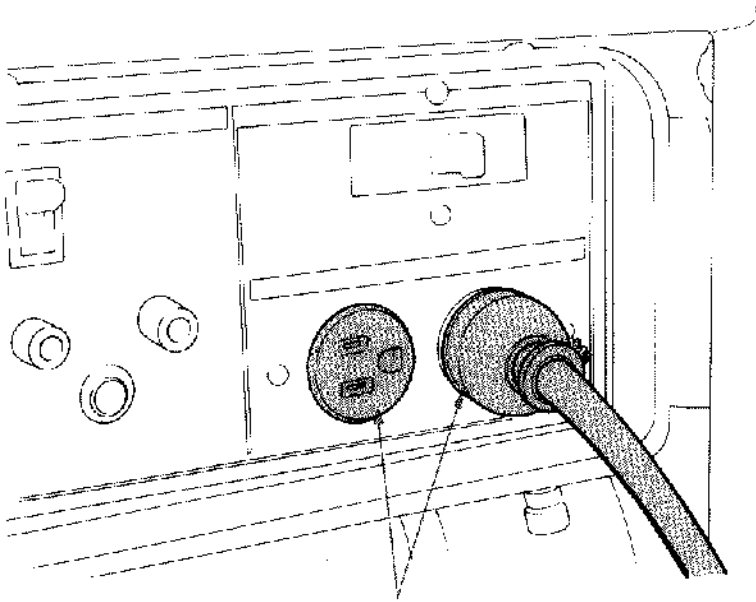

AC RECEPTACLES

DC application

The DC terminals may be used for charging 12 volt automotive-type batteries only.

WARNING Batteries produce explosive gases. Keep sparks, flames, and cigarettes away. To prevent the possibility of creating a spark near the battery, connect charging cables first to the battery, then to the generator, and disconnect cables first at the generator.

CAUTION:

- Do not attempt to start an automobile engine with the generator still connected to the battery. The generator may be damaged.
- Connect the positive battery terminal to the positive generator terminal. Do not reverse the charging cables, or serious damage to the generator and/or battery may occur.

NOTE:

- The DC terminals may be used while the AC power is in use.
- An overloaded DC circuit will trip the DC circuit protector (push button comes out). If this happens, wait a few minutes before pushing the circuit protector to resume operation.

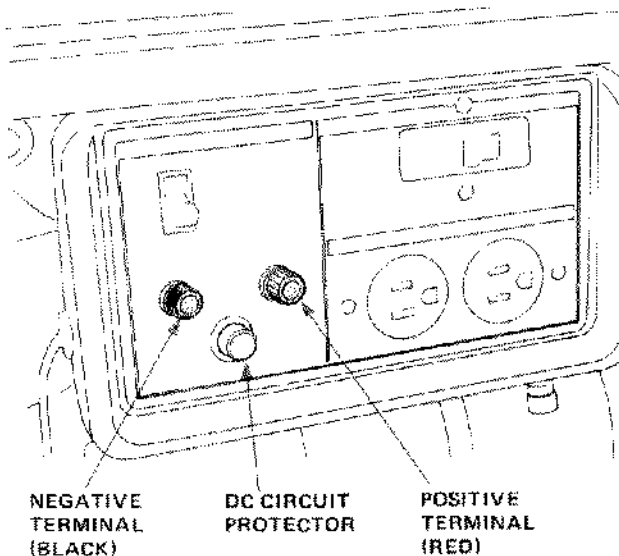

6. STOPPING THE ENGINE

To stop the engine in an emergency, turn the engine switch OFF.

In normal use:

1. Turn the AC circuit breaker off and/or disconnect the charging cords at the DC terminals.

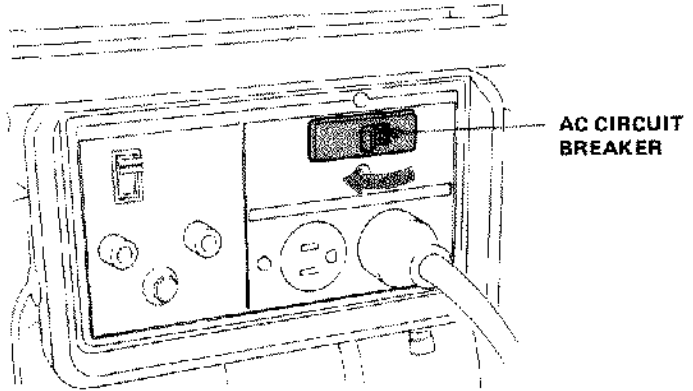

2. Turn the engine switch OFF.

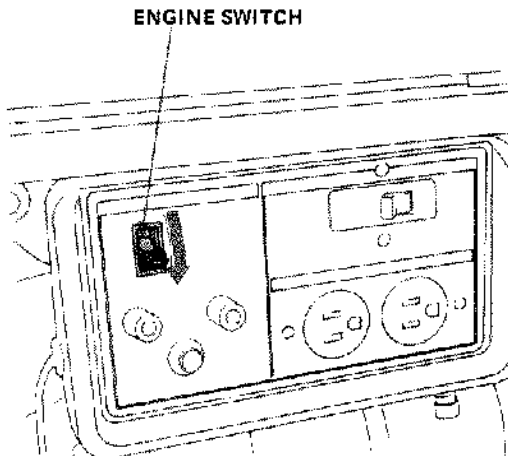

3. Turn the fuel valve OFF.

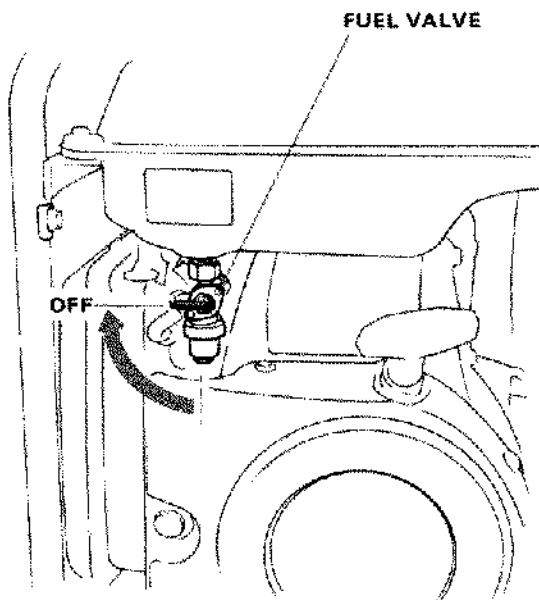

7. MAINTENANCE

The purpose of the maintenance schedule and adjustment is to keep the generator in the best operating condition.

Inspect or service as scheduled in the table on the next page.

WARNING Shut off the engine before performing any maintenance. If the engine must be run, make sure the area is well ventilated. The exhaust contains poisonous carbon monoxide gas.

CAUTION: Use only genuine HONDA parts or their equivalent. The use of replacement parts which are not of equivalent quality may damage the generator.

Maintenance Schedule

REGULAR SERVICE PERIOD Perform at every indicated month or operating hour interval, whichever occurs first.		Daily	First month or 20 Hrs.	Every 3 months or 50 Hrs.	Every 6 months or 100 Hrs.	Every year or 300 Hrs.
ITEM						
Engine oil	Inspection	●				
	Change		●		●	
Air cleaner element	Inspection	●				
	Cleaning			● (1)		
Fuel filter cleaning					●	
Spark plug maintenance					●	
Valve clearance adjustment						● (2)
Combustion chamber and valve cleaning						● (2)
Fuel line inspection (Replace if necessary)						●
Spark arrester		Clean every 100 operating hours.				

NOTE (1) : Service more frequently when used in dusty areas.

(2) : These items should be serviced by an authorized Honda dealer, unless the owner has the proper tools and is mechanically proficient. See the Honda Shop Manual.

Cont'd

Tool kit

The tools supplied are necessary for performing some periodic maintenance, simple adjustments and repairs.

Always keep the kit with the generator.

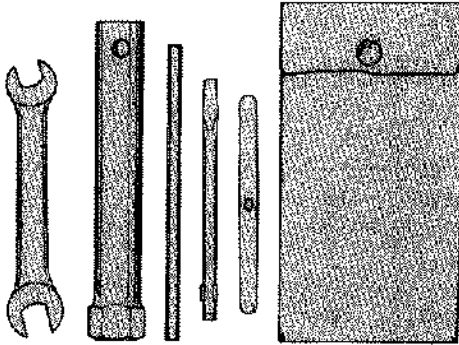

Changing oil

Drain the oil while the engine is still warm to assure rapid and complete draining.

1. Remove the drain plug and filler cap, and drain the oil. Retighten the plug securely.
2. Refill with the recommended oil (see page 4) and check the level.

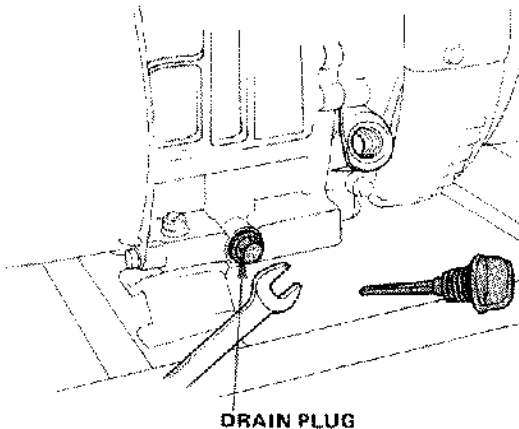

Air cleaner service

A dirty air cleaner will restrict air flow to the carburetor. To prevent carburetor malfunction, service the air cleaner regularly (page 17). Service more frequently when operating the generator in extremely dusty areas.

WARNING: Do not use gasoline or low flash point solvents for cleaning. They are flammable and explosive under certain condition.

CAUTION: Never run the generator without the air cleaner. Rapid engine wear may result.

1. Loosen the wing bolt, remove the air cleaner cover and remove the element.

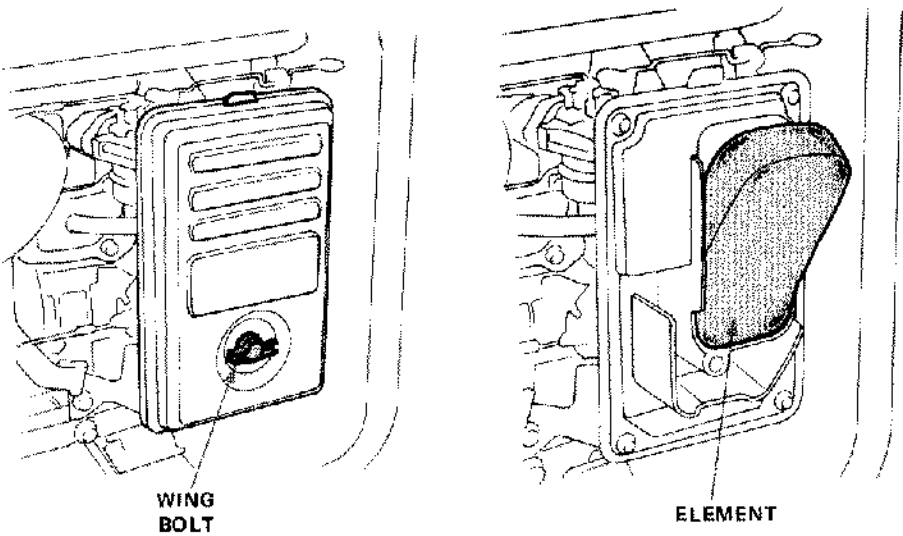

Cont'd

-
2. Wash the element in a non-flammable or high flash point solvent and dry it thoroughly.
 3. Soak the element in clean engine oil and squeeze out the excess oil.
 4. Reinstall the air cleaner element and the cover.

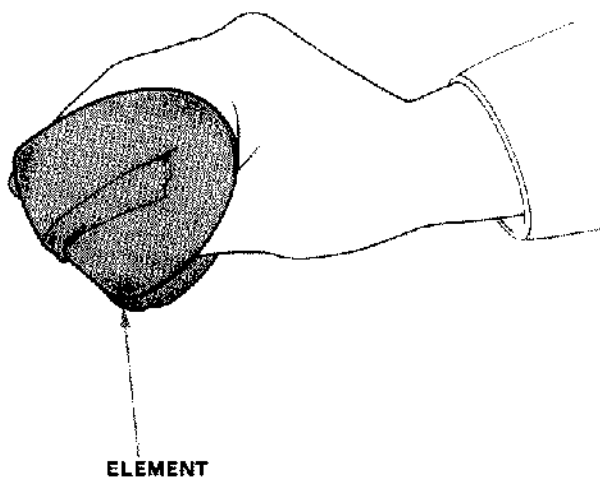

Fuel filter service

The filter prevents dirt or water which may be in the fuel tank from entering the carburetor. If the engine has not been run for a long time, the filter should be cleaned.

1. Turn the fuel valve OFF. Remove the filter cup.
2. Clean the cup thoroughly.
3. Reassemble. Do not damage the rubber gasket.

Warning After installing the filter cup, check for fuel leaks and make sure the area is dry before starting the engine.

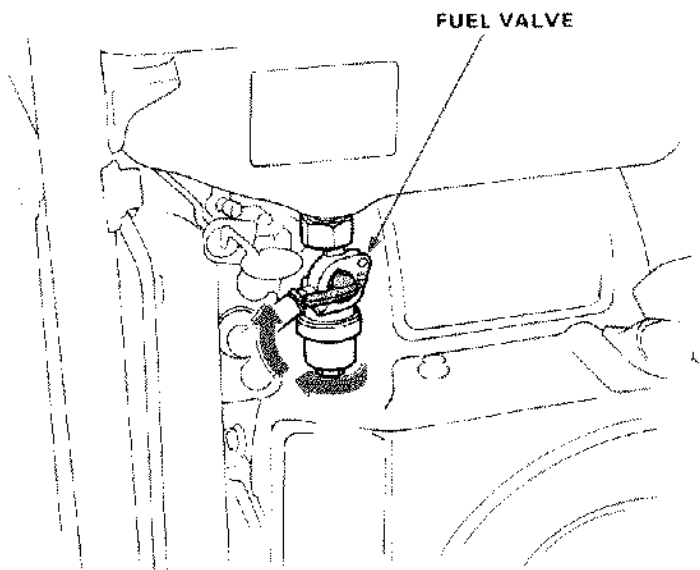

Cont'd

Spark plug service

Recommended spark plug: BR-4HS (NGK), W14FR-U (ND)

To ensure proper engine operation, the spark plug must be properly gapped and free of deposits.

1. Remove the spark plug cover.
2. Clean any dirt from around the spark plug base.
3. Remove the spark plug cap.

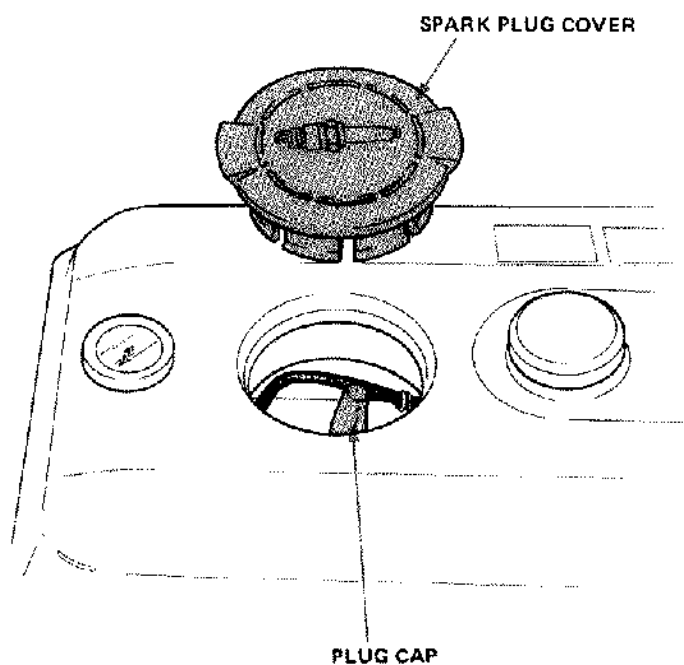

4. Use the wrench supplied in the tool kit to remove the spark plug.
5. Visually inspect the spark plug. Discard it if the insulator is cracked or chipped.
6. Measure the plug gap with a feeler gauge.
The gap should be 0.6–0.7 mm (0.024–0.028 in). Correct as necessary by bending the side electrode.
7. Attach the plug washer. Thread the plug in by hand to prevent cross-threading.
8. Tighten a new spark plug 1/2 turn with the wrench to compress the washer. If you are reusing a plug, it should only take 1/8–1/4 turn after the plug seats.

CAUTION:

- The spark plug must be securely tightened. An improperly tightened plug can become very hot and possibly damage the generator.
- Never use a spark plug with an improper heat range.

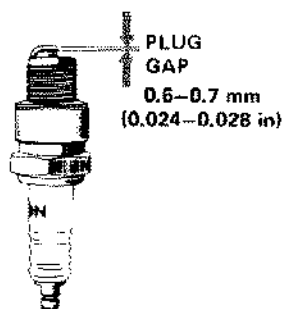
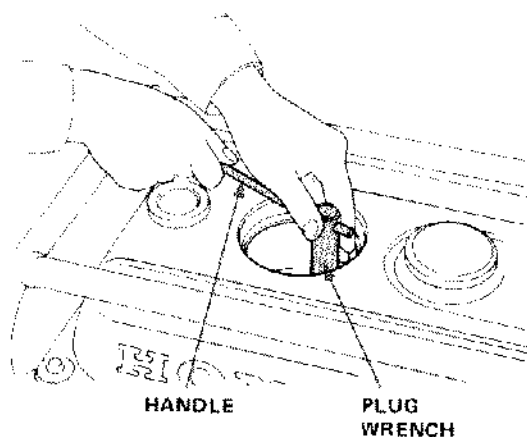

Cont'd

Spark arrester maintenance

WARNING If the generator has been running, the muffler will be very hot. Allow it to cool before proceeding.

CAUTION: The spark arrester must be serviced every 100-hours to maintain its efficiency.

1. Loosen two 6 mm bolts and two 8 mm nuts and remove the muffler and gasket.
2. Loosen six 6 mm bolts to separate the protectors and loosen two 8 mm bolts to remove the exhaust pipe.
3. Check the muffler exhaust port for carbon deposits; clean if necessary.
4. Remove the spark arrester from the muffler. Clean the screen and inspect it for damage. Replace if necessary.
5. Install the spark arrester in the muffler. Install the muffler and gasket and tighten the bolts and nuts securely.

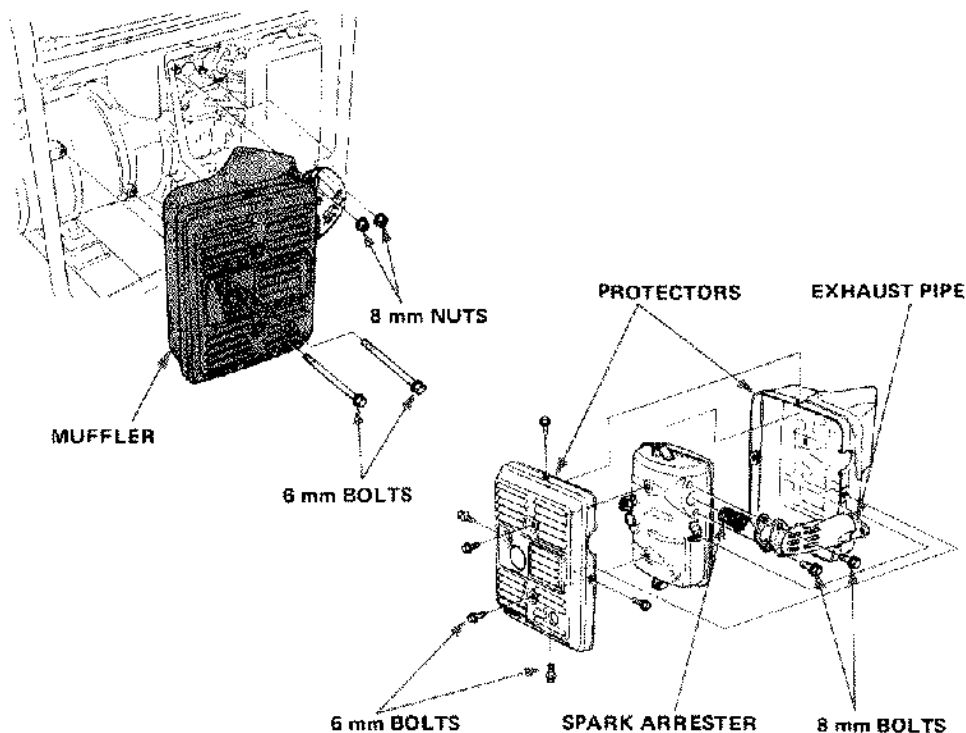

8. TRANSPORTING/STORAGE

Warning When transporting the generator, turn the engine switch OFF and keep the generator level to prevent fuel spillage. Fuel vapor or spilled fuel may ignite.

Before storing the unit for an extended period:

1. Be sure the storage area is free of excessive humidity and dust.
2. Drain the fuel –
 - a. With the fuel valve OFF, remove and empty the filter cup.
 - b. Turn the fuel valve ON and drain the gasoline in the fuel tank into a suitable container.
 - c. Replace the filter cup and tighten securely.

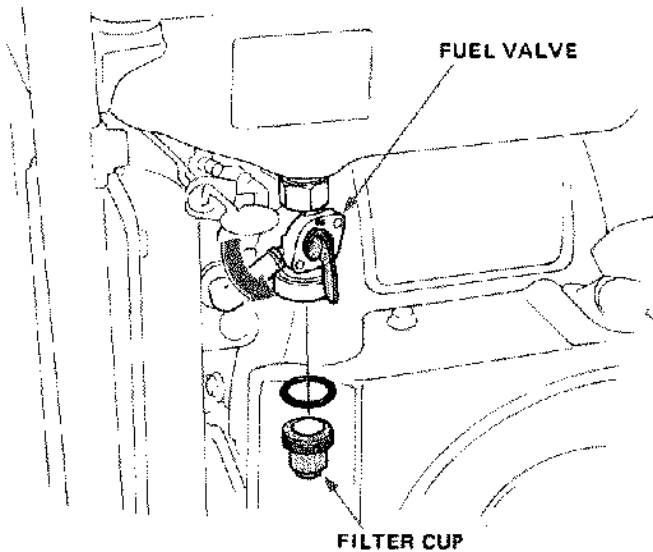

Cont'd

-
- d. Drain the carburetor by loosening the drain screw. Drain the gasoline into a suitable container.

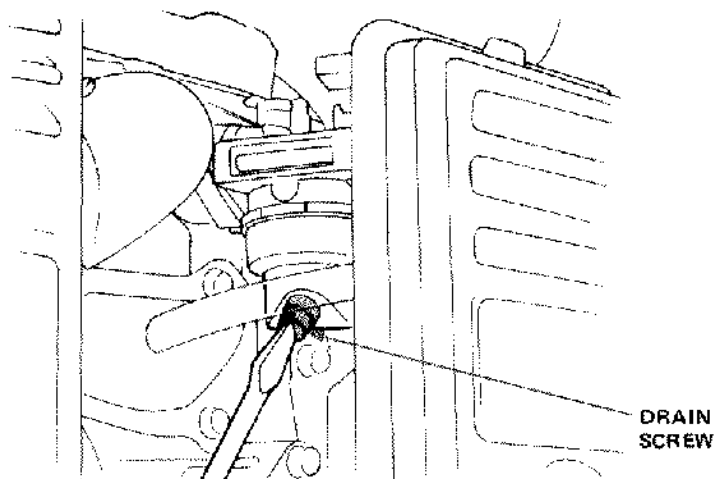

- e. Pull the starter grip until resistance is felt; the piston is coming up on its compression stroke. At this position, the exhaust and intake valves are closed, and this will help protect the engine from corrosion.

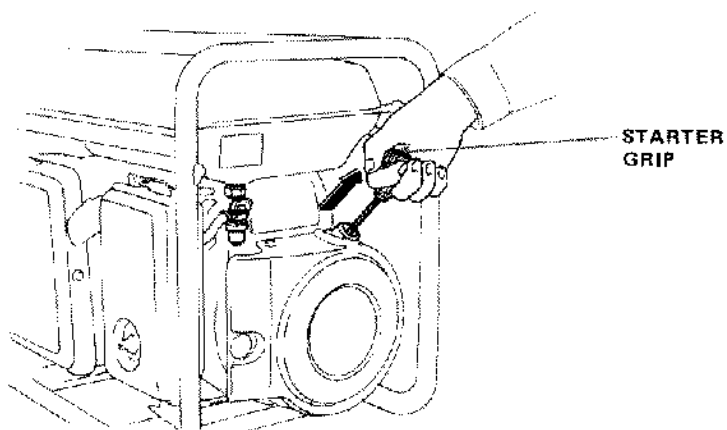

9. TROUBLESHOOTING

A. When the engine will not start:

1. Is there enough fuel?
2. Is the fuel valve on?
3. Is gasoline reaching the carburetor?

To check, loosen the drain screw with the fuel valve on.

WARNING If any fuel is spilled, make sure the area is dry before testing the spark plug or starting the engine. Fuel vapor or spilled fuel may ignite.

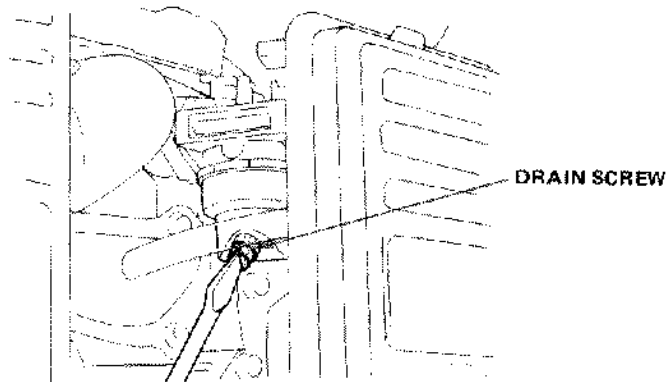

4. Is there enough oil in the crankcase?
5. Is the AC circuit breaker off and nothing connected to the DC terminals?
6. Is the engine switch on?
7. Is there a spark at the spark plug (page 22)?

Cont'd

-
- a. Remove the spark plug cover and cap. Clean any dirt form around the spark plug base, then remove the spark plug.
 - b. Install the spark plug in the plug cap.
 - c. Turn the engine switch on.
 - d. Grounding the side electrode to the stay, pull the recoil starter to see if sparks jump across the gap.

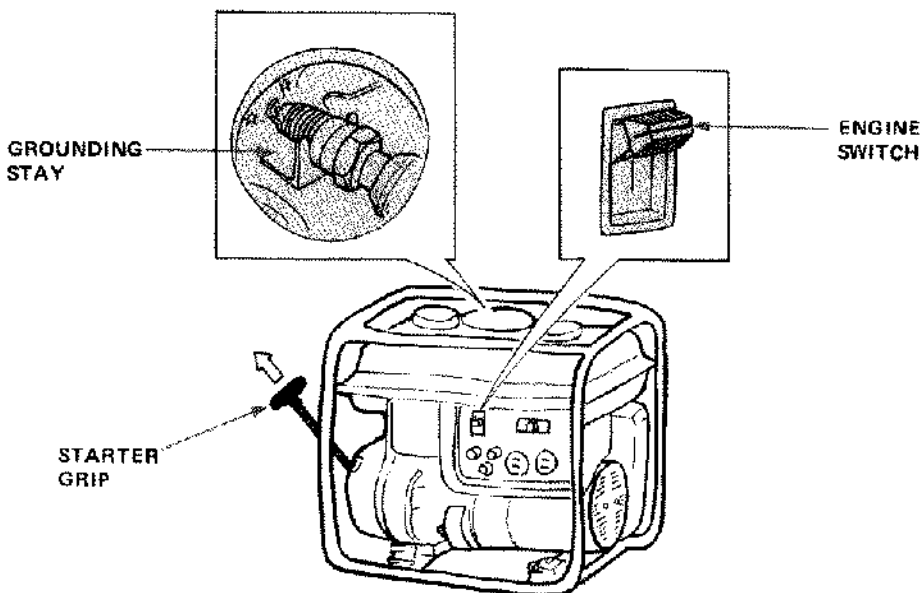

- e. If there are no sparks, replace the plug.
If OK, try to start the engine according to the instructions.
6. If the engine does not start yet, take the generator to the dealer.

-
- B. When the engine starts but stops immediately:
Is there enough oil in the crankcase?
If not, the engine switch will turn off after starting.
- C. No electricity at the AC receptacles:
1. Is the AC circuit breaker on?
2. Check the electrical appliance or equipment for any defects.
- D. No electricity at the DC terminals:
1. Is the DC circuit protector on?
2. Check the electrical appliance or equipment for any defects.

10. SPECIFICATIONS

Dimensions

Length x Width x Height	545 x 360 x 475 mm (21.5 x 14.2 x 18.7 in)
Dry weight	44.8 kg (98.8 lb)

Engine

Model	Honda GE200
Engine Type	4-Stroke, side valve, 1 cylinder
Displacement [Bore x Stroke]	197 cc (12.0 cu in) [67 x 56 mm (2.6 x 2.2 in)]
Compression Ratio	6.5 : 1
Engine Speed	3,600 rpm
Cooling System	Forced air cooling
Ignition System	Flywheel magneto
Oil Capacity	0.7 ℓ (0.75 US qt)
Fuel Tank Capacity	10 ℓ (2.6 US gal)
Spark Plug	BR-4HS (NGK), W14FR-U (ND)

Generator

AC output	Rated voltage	120 V
	Rated frequency	60 Hz
	Rated ampere	11.7 A
	Rated output	1.4 kVA
	Maximum output	1.6 kVA
DC output	Only for charging 12 V automotive batteries.	
	Maximum charging output = 8.3 A.	

11. WIRING DIAGRAM

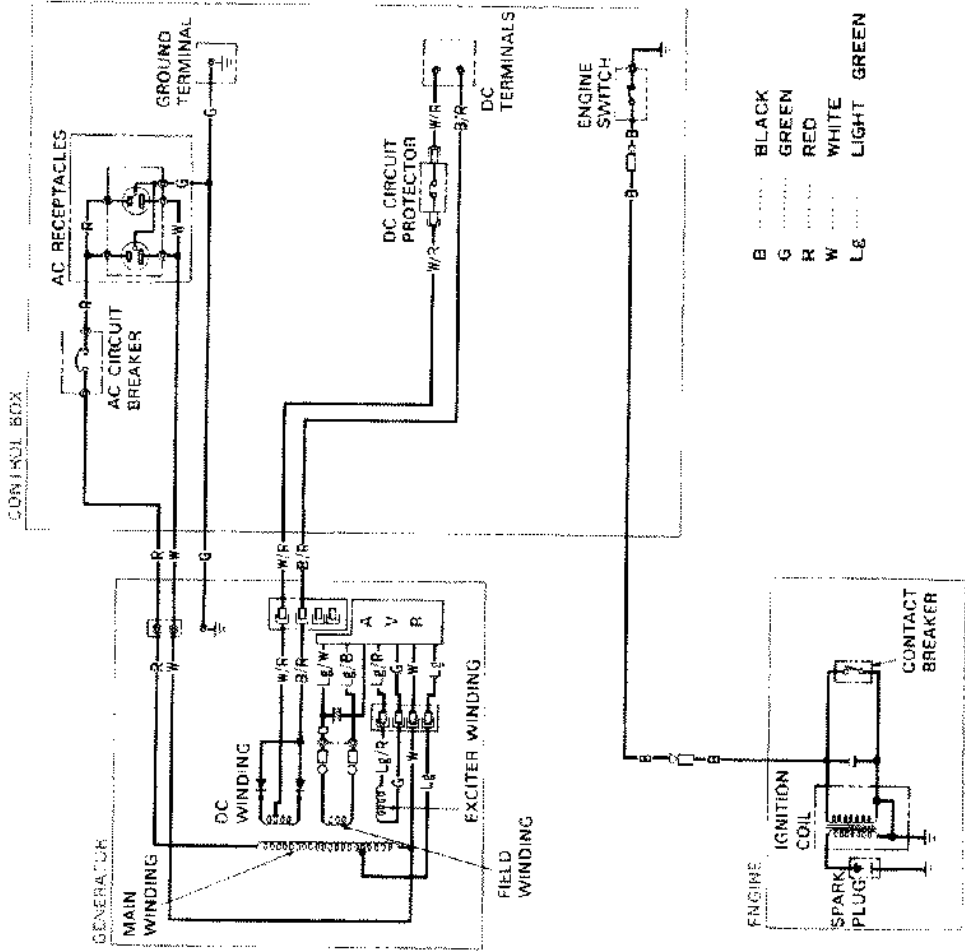

Current customer service contact information:

United States, Puerto Rico, and U.S. Virgin Islands:

Honda Power Equipment dealership personnel are trained professionals. They should be able to answer any question you may have. If you encounter a problem that your dealer does not solve to your satisfaction, please discuss it with the dealership's management. The Service Manager or General Manager can help. Almost all problems are solved in this way.

If you are dissatisfied with the decision made by the dealership's management, contact the Honda Power Equipment Customer Relations Office. You can write:

American Honda Motor Co., Inc.
Power Equipment Division
Customer Relations Office
4900 Marconi Drive
Alpharetta, GA 30005-8847

Or telephone: (770) 497-6400 M-F, 8:30 am - 5:00 pm EST

When you write or call, please provide the following information:

- Model and serial numbers
- Name of the dealer who sold the Honda power equipment to you
- Name and address of the dealer who services your equipment
- Date of purchase
- Your name, address, and telephone number
- A detailed description of the problem

NOTE

NOTE

NOTE



HONDA
HONDA MOTOR CO., LTD. TOKYO, JAPAN

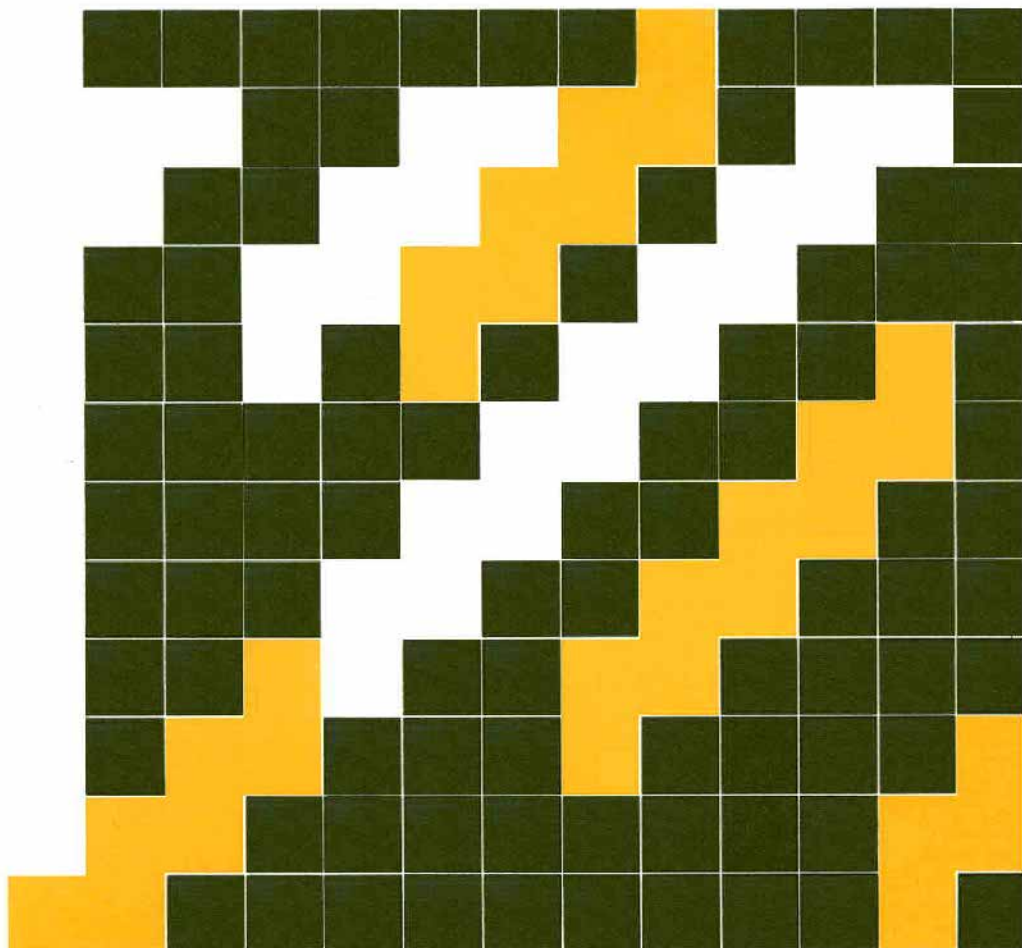

3189710

英 Y B10008109
PRINTED IN JAPAN