



OWNER'S MANUAL

EG2800i

GENERATOR

Before operating the generator for the first time, please read this Owner's Manual. Even if you have operated other generators, take time to become familiar with how this generator operates.

QUICK FIND

Air Cleaner	12	Engine Oil Change	11	Maintenance Schedule	10
AC Operation	8	Engine Oil Recommendations	12	Refueling	11
Dealer Locator Information	19	Fuel Recommendations	11	Spark Plug	12
Engine Oil Level Check	11	How to Contact Honda	19		

CONTENTS

FOR YOUR SAFETY	2	SERVICING YOUR GENERATOR... ..	9	TROUBLESHOOTING	14
GENERATOR SAFETY	2	The Importance of Maintenance ...	9	Engine Will Not Start	14
INITIAL USE INFORMATION	4	Maintenance Safety	9	Loss of Power	14
Add Engine Oil	4	Maintenance Schedule	10	No Power at the AC Receptacles	14
Fuel	4	Refueling	11	TECHNICAL INFORMATION	15
Please Register Your Generator ...	4	Fuel Recommendations	11	Serial Number Locations	15
Before Using Your Generator	4	Engine Oil Level Check	11	High Altitude Operation	15
BEFORE EACH USE	5	Engine Oil Change	11	Emission Control System	15
Check Your Generator	5	Engine Oil Recommendations	12	Air Index	16
CONTROLS & FEATURES	5	Air Cleaner	12	Specifications	16
Component and Control Locations	5	Spark Plug	12	Wiring Diagram	17
Controls	6	Sediment Cup Cleaning	13	AVOIDING FUEL-RELATED PROBLEMS	18
Features	6	Spark Arrester	13	CUSTOMER INFORMATION	19
OPERATION	7	TRANSPORTING	13	Parts, Service Items & Accessories	19
Safe Operating Instructions	7	STORAGE	13	Dealer Locator Information	19
Starting the Engine	7	Fuel	13	How to Contact Honda	19
Stopping the Engine	8	Cleaning	14	Honda Publications	19
AC Operation	8	Oil	14	DISTRIBUTOR'S LIMITED WARRANTY	20
Eco Throttle System	8	Storage Location	14	EMISSION SYSTEM WARRANTY	21
Standby Power	9	Removing from Storage	14	PRODUCT REGISTRATION	23
Special Requirements	9				

QUESTIONS?

Contact your Honda dealer.
There is a dealer locator at
powerequipment.honda.com

HONDA



WELCOME

Congratulations on your selection of a Honda generator!

We are certain you will be pleased with your purchase of one of the finest generators on the market. We want to help you get the best results from your new generator and to operate it safely. This manual contains information on how to do that; please read it carefully.

When your generator needs scheduled maintenance, keep in mind that Honda Power Equipment servicing dealership personnel are specially trained in servicing Honda generators and are supported by the parts and service divisions of American Honda.

Please read the *DISTRIBUTOR'S LIMITED WARRANTY* on page 20 and the *EMISSION CONTROL SYSTEM WARRANTY* on page 21 to fully understand what is covered by warranty and your responsibilities of ownership.

FOR YOUR SAFETY

Your safety and the safety of others are very important. We have provided important safety messages in this manual and on the generator. This information alerts you to potential hazards that could hurt you or others. Please read these messages carefully.

Of course, it is not practical or possible to warn you about all the hazards associated with operating or maintaining a generator. You must use your own good judgment.

Safety Instructions

You will find important safety information in a variety of forms:

Safety Labels – on the generator

Instructions – how to use this generator correctly and safely

Safety Messages – preceded by a safety alert  symbol and one of three signal words: DANGER, WARNING, or CAUTION.

Each message tells you what the hazard is, what can happen, and what you can do to avoid or reduce injury.

These signal words mean:

 **DANGER**

You **WILL** be KILLED or SERIOUSLY HURT if you don't follow instructions.

 **WARNING**

You **CAN** be KILLED or SERIOUSLY HURT if you don't follow instructions.

 **CAUTION**

You **CAN** be HURT if you don't follow instructions.

Damage Prevention Messages – you will also see other important messages that are preceded by the word NOTICE. This word means:

 **NOTICE**

Your engine, other property, or the environment can be damaged if you don't follow instructions.

**WARNING:**

The engine exhaust from this product contains chemicals known to the State of California to cause cancer, birth defects, or other reproductive harm.

 **WARNING**

Exhaust contains poisonous carbon monoxide gas that can build up to dangerous levels in a closed area.

Breathing carbon monoxide can cause unconsciousness or death.

Never run the generator in a closed, or even partly closed area where people may be present.

GENERATOR SAFETY

Important Safety Information

Honda generators are designed for use with electrical equipment that has suitable power requirements. Other uses can result in injury to the operator or damage to the generator and other property.

Most injuries or property damage can be prevented if you follow all the instructions in this manual and on the generator. The most common hazards are discussed below, along with the best way to protect yourself and others.

Never attempt to modify the generator. It could result in an injury as well as damage to the generator and/or the attached appliances.

- Do not connect an extension to the muffler.
- Do not modify the intake system.
- Do not remove the control panel or change the control panel wiring.

Operator Responsibility

- Know how to stop the generator quickly in case of emergency.
- Understand the use of all generator controls, output receptacles, and connections.
- Be sure that anyone who operates the generator receives proper instruction. Do not let children operate the generator without parental supervision.

Carbon Monoxide Hazards

A generator's exhaust contains toxic carbon monoxide, which you cannot see or smell. Breathing carbon monoxide can KILL YOU IN MINUTES. To avoid carbon monoxide poisoning, follow these instructions when operating a generator:

- Never operate a generator inside a house, garage, basement, crawl space, or any enclosed or partially enclosed space.
- Only run a generator OUTSIDE, far away from windows, doors, and vents.
- Never operate a generator near open doors or windows.
- Get fresh air and seek medical attention immediately if you suspect you have inhaled carbon monoxide.

Early symptoms of carbon monoxide exposure include headache, fatigue, shortness of breath, nausea, and dizziness. Continued exposure to carbon monoxide can cause loss of muscular coordination, loss of consciousness, and then death.

Electric Shock Hazards

- The generator produces enough electric power to cause a serious shock or electrocution if misused.
- Using a generator or electrical appliance in wet conditions, such as rain or snow, or near a pool or sprinkler system, or when your hands are wet, could result in electrocution. Keep the generator dry.
- If the generator is stored outdoors, unprotected from the weather, check all of the electrical components on the control panel before each use. Moisture or ice can cause a malfunction or short circuit in electrical components that could result in electrocution.
- Do not connect to a building's electrical system unless an isolation (transfer) switch has been installed by a qualified electrician.

Fire and Burn Hazards









- The exhaust system gets hot enough to ignite some materials.
 - Keep the generator at least 3 feet (1 meter) away from buildings and other equipment during operation.
 - Do not enclose the generator in any structure.
 - Keep flammable materials away from the generator.
- The muffler becomes very hot during operation and remains hot for a while after stopping the engine. Be careful not to touch the muffler while it is hot. Let the engine cool before storing the generator indoors.

Refuel With Care

- Gasoline is extremely flammable, and gasoline vapor can explode.
- Do not refuel during operation.
- Allow the engine to cool if it has been in operation.
- Refuel only outdoors in a well-ventilated area and on a level surface.
- Never smoke near gasoline, and keep other flames and sparks away.
- Do not overfill the fuel tank. Overfilling the fuel tank may cause fuel to leak out of the bottom of the EVAP canister.
- Make sure that any spilled fuel has been wiped up before starting the engine.
- Always store gasoline in an approved container.

Safety Label Locations

These labels warn you of potential hazards that can cause serious injury. Read them carefully. If a label comes off or becomes hard to read, contact an authorized Honda servicing dealer for a replacement.

	CAUTION A hot exhaust system can cause serious burns. ■ Avoid contact if the engine has been running.
DANGER Using a generator indoors CAN KILL YOU IN MINUTES. Generator exhaust contains carbon monoxide. This is a poison you cannot see or smell.	
	
NEVER use inside a home or garage, EVEN IF doors and windows are open.	Only use OUTSIDE and far away from windows, doors, and vents.
WARNING	
	Gasoline is highly flammable and explosive. You could be burned or seriously injured if the gasoline is ignited. ■ Before refueling, stop the engine and keep heat, sparks, and flame away. ■ Handle fuel only outdoors. ■ Do not fill the fuel tank above the upper limit line. ■ Wipe up spills immediately.
	Exhaust contains poisonous carbon monoxide gas that can build up to dangerous levels in closed areas. Breathing carbon monoxide can cause unconsciousness or death. ■ Never run the generator in a closed, or even partly closed area where people may be present.
	Improper connections to a building can allow electrical current to backfeed into utility lines, creating an electrocution hazard. ■ Connections to a building must isolate generator power from utility power and comply with all applicable laws and electrical codes.
	The generator is a potential source of electrical shock if not kept dry. ■ Do not expose the generator to moisture, rain or snow. ■ Do not operate the generator with wet hands.
	Read owner's manual carefully before operation.



	WARNING DO NOT OVERFILL! Do not fill tank past red limit mark. Overfilling can result in fuel flowing through the vent tube and causing a leak and fire. You can be burned or seriously injured.
---	---

WARNING Operation of This Equipment May Create Sparks That Can Start Fires Around Dry Vegetation. A Spark Arrestor May be Required. The Operator Should Contact Local Fire Agencies For Laws or Regulations Relating to Fire Prevention Requirements. Per California Public Resources Code 4442.6

INITIAL USE INFORMATION

Add Engine Oil

The generator is shipped **WITHOUT OIL** in the engine. Place the generator on a level surface. Remove the oil filler cap/dipstick.

All Honda engines are run at the factory prior to packaging. Most of the oil is removed prior to shipment; however, some oil remains in the engine. The amount of oil left in the engine varies.

Add enough SAE 10W-30 API service category SJ or later oil to bring the oil level to the upper limit of the oil filler neck (approximately 15 to 16 ounces is required). 10W-30 motor oil is recommended for general use. For additional recommendations, see [page 12](#).

Do not overfill the engine with oil. If the engine is overfilled, the excess oil may get transferred to the air cleaner housing and air filter. An indication of overfilling is white or blue smoke coming from the muffler when the engine is running.

After filling the engine with oil, screw the oil filler cap/dipstick in and remove the hang tag located on the fuel cap that says “*The engine has no oil.*”

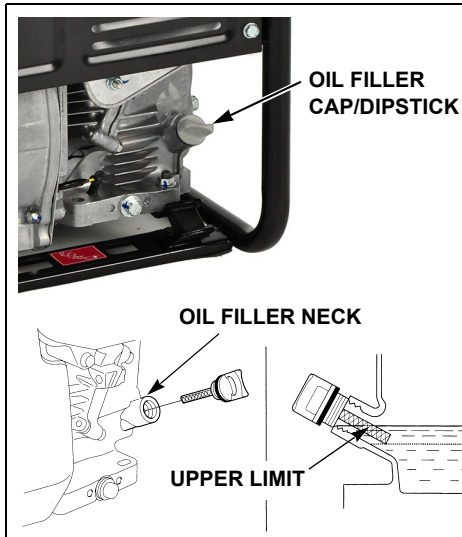

1. Remove the fuel tank cap.
2. Add fuel slowly to prevent spilling. Do not fill the fuel tank above the upper level mark (red) on the fuel strainer. Overfilling the fuel tank may cause fuel to leak out of the bottom of the EVAP canister.
3. After adding fuel, reinstall the fuel tank cap securely.

Move the generator at least 10 feet (3 meters) away from the fueling source and site before starting the engine.

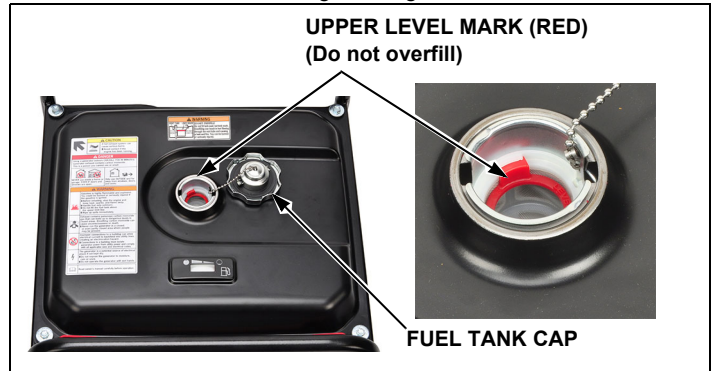

NOTICE

Fuel can damage paint and plastic. Be careful not to spill fuel when filling your fuel tank. Damage caused by spilled fuel is not covered under the DISTRIBUTOR'S LIMITED WARRANTY.

Please Register Your Generator

Please take a few minutes and register your purchase with Honda. You can register:

- By completing and mailing the registration card on the back cover of this book
- Going online to powerequipment.honda.com and clicking on Product Registration
- By scanning the QR code



Fuel

Add fuel to the generator in a well-ventilated area. Never refuel the engine inside a building where gasoline fumes may reach flames or sparks. Keep gasoline away from appliance pilot lights, barbecues, electric appliances, power tools, etc. Spilled fuel is not only a fire hazard, it causes environmental damage. Wipe up spills immediately.

This engine is certified to operate on unleaded gasoline with a pump octane rating of 86 or higher containing no more than 10% ethanol (E10) or 5% methanol by volume. Refer to [page 11](#) for additional fuel recommendations.

⚠ WARNING

Gasoline is highly flammable and explosive.

You can be burned or seriously injured when handling fuel.

- Stop the engine and let it cool before refueling
- Keep heat, sparks, and flame away
- Refuel only outdoors
- Wipe up spills immediately

Before Using Your Generator

All Generator operators must read the following sections:

- FOR YOUR SAFETY ([page 2](#))
- GENERATOR SAFETY ([page 2](#))
- BEFORE EACH USE ([page 5](#))
- OPERATION ([page 7](#))
- STARTING THE ENGINE ([page 7](#))
- STOPPING THE ENGINE ([page 8](#))
- MAINTENANCE SCHEDULE ([page 10](#))

BEFORE EACH USE

Your safety is your responsibility. A little time spent in preparation will significantly reduce your risk of injury.

Read and understand this manual. Know what the controls do and how to operate them.

Familiarize yourself with the generator and its operation before you begin using it. Know how to quickly shut off the generator in case of an emergency.

Check Your Generator

For your safety, and to maximize the service life of your generator, it is very important to take a few moments before you operate the generator to check its condition. Be sure to take care of any problem you find, or have your servicing dealer correct it, before you operate the generator.

⚠ WARNING

Improperly maintaining this generator, or failing to correct a problem before operation, could cause a significant malfunction.

Some malfunctions can seriously hurt or kill you.

Always perform a pre-operation inspection before each operation, and correct any problem.

- Make sure the generator is on a level surface
- Look around and underneath the generator for signs of oil or gasoline leaks
- Look for signs of damage
- Check each control for proper operation
- Check that all nuts, bolts, and screws are tightened
- Check the air filter ([page 12](#)) and oil level ([page 11](#))
- Check the fuel level ([page 7](#)). Starting with a full tank will help to eliminate or reduce operating interruptions for refueling.

CONTROLS & FEATURES

Component and Control Locations

Use the illustrations on these pages to locate and identify the most frequently used controls.

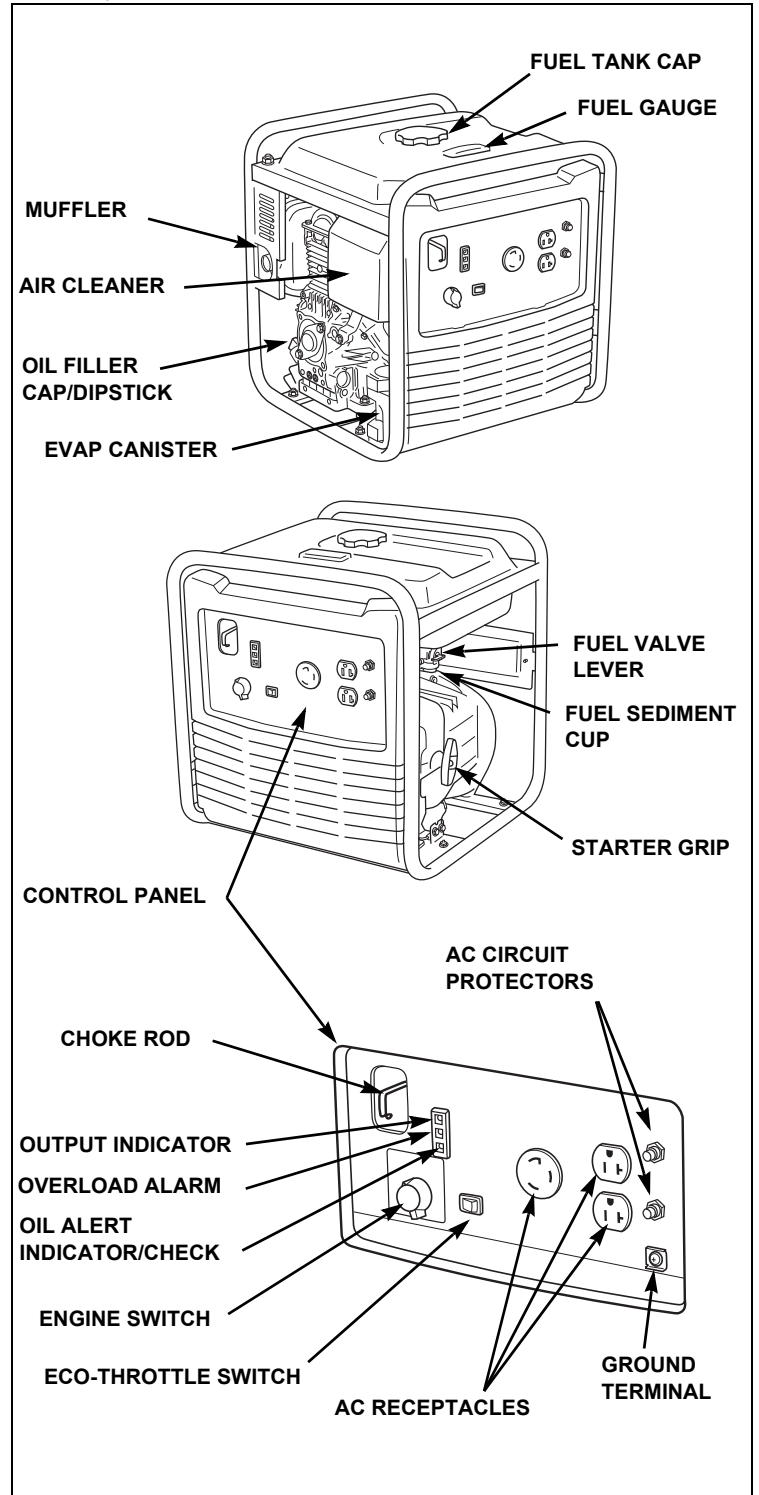

Controls

Fuel Valve Lever

The fuel valve lever is located between the fuel tank and carburetor.

The fuel valve lever must be in the ON position for the engine to run.

After stopping the engine, turn the fuel valve lever to the OFF position.

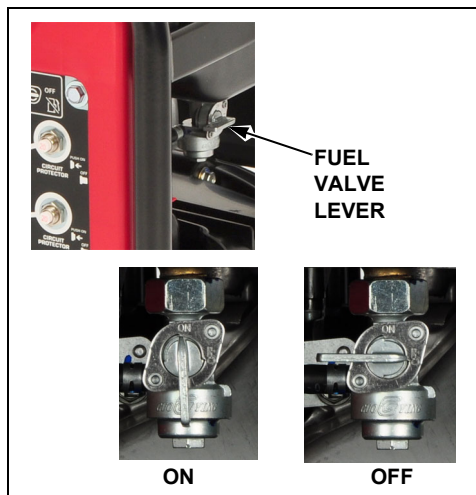

Choke Rod

The choke rod opens and closes the choke valve in the carburetor.

Pulling the choke rod to the CLOSED position enriches the fuel mixture for starting a cold engine.

Pushing the choke rod to the OPEN position provides the correct fuel mixture for operation after starting, and for restarting a warm engine.

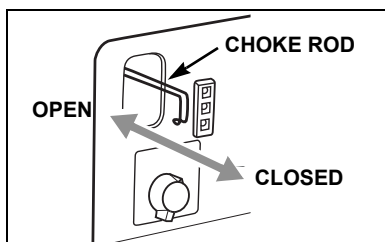

Engine Switch

The engine switch controls the ignition system.

OFF - Stops the engine.

ON - Running position, and for starting with the recoil starter.

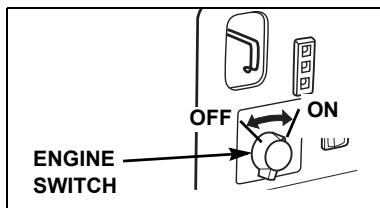

Recoil Starter

Pulling the starter grip operates the recoil starter to crank the engine.

NOTICE

Do not allow the starter grip to snap back against the engine. Return it gently to prevent damage to the starter. Do not let the starter rope rub against the generator body, or the rope will wear out prematurely.

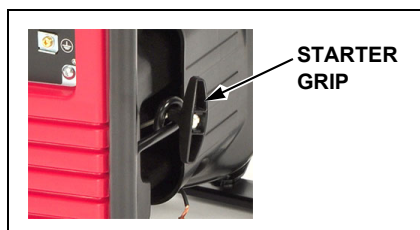

AC Circuit Protector

The AC circuit protector will automatically switch to OFF if there is a short circuit or a significant overload of the generator at the 20A receptacles. If an AC circuit protector switches OFF automatically, check that the appliance is working properly and does not exceed the rated load capacity of the circuit before resetting the AC circuit protector ON.

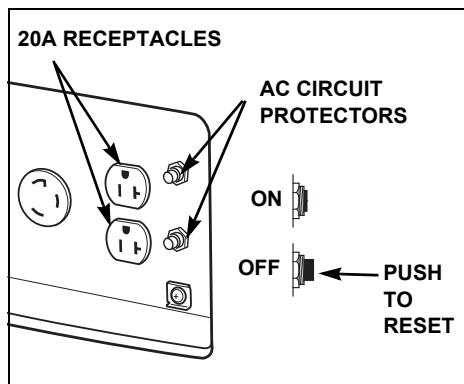

ECO THROTTLE® Switch

The Eco Throttle system automatically reduces engine speed when loads are turned off or disconnected. When appliances are turned on or reconnected, the engine returns to the proper speed to power the electrical load.

If high electrical loads are connected simultaneously, turn the Eco Throttle switch to the OFF position to reduce voltage changes.

ON: Recommended to minimize fuel consumption and further reduce noise levels when less than a full load is applied to the generator.

OFF: The Eco Throttle system does not operate. Generator operates at full speed.

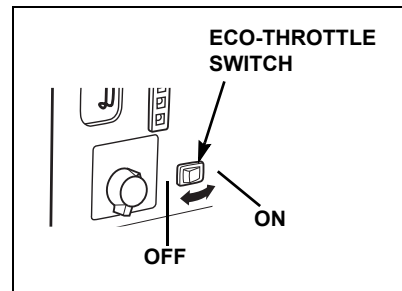

Features

Output Indicator

The output indicator (green) is illuminated when the generator is operating normally. It indicates that the generator is producing electrical power at the receptacles.

In addition, the output indicator has a simplified hour meter function. When you start the engine, the indicator blinks according to the generator's cumulative operating hours as follows:

- No blinks: 0~100 hours
- 1 blink: 100~200 hours
- 2 blinks: 200~300 hours
- 3 blinks: 300~400 hours
- 4 blinks: 400~500 hours
- 5 blinks: 500 or more hours

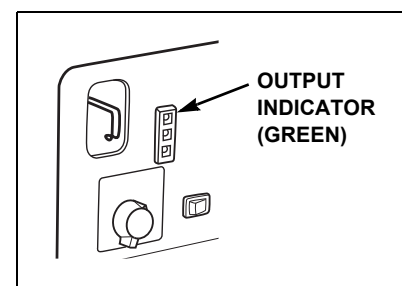

Overload Alarm (Indicator)

If the generator is overloaded (in excess of 2.8kVA), or if there is a short circuit in a connected appliance, the overload alarm (red) will come ON. The overload alarm (red) will stay ON, and after about 4~10 seconds, current to the connected appliance(s) will shut off, and the output indicator (green) will go OFF. However, the engine will continue to run.

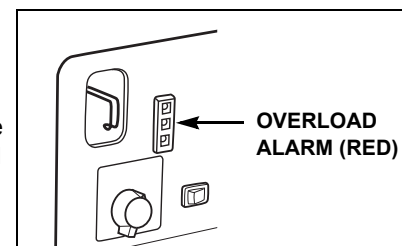

Oil Alert® Indicator/Check

The Oil Alert system is designed to prevent engine damage caused by an insufficient amount of oil in the crankcase. Before the oil level in the crankcase can fall below a safe limit, the Oil Alert indicator/check (red) comes on and the Oil Alert system automatically will stop the engine (the engine switch will remain in the ON position).

If the engine stops or the Oil Alert indicator/check (red) comes on when you pull the starter grip, check the engine oil level ([page 11](#)) before troubleshooting in other areas.

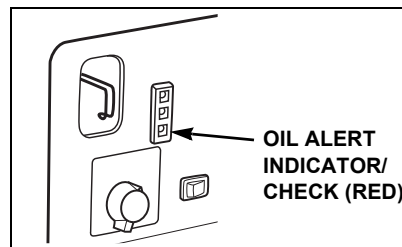

Ground Terminal

The generator ground terminal is connected to the frame of the generator, the metal non-current-carrying parts of the generator, and the ground terminals of each receptacle.

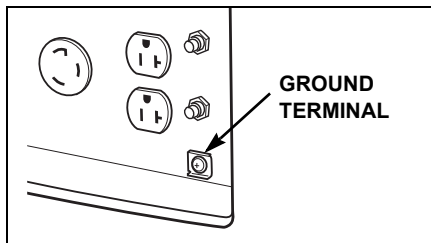

Before using the ground terminal, consult a qualified electrician, electrical inspector, or local agency having jurisdiction for local codes or ordinances that apply to the intended use of the generator.

Fuel Gauge

The fuel gauge is a mechanical device that measures the fuel level in the tank. The red indicator in the window will reference the level in relation to full or empty. To provide increased operating time, start with a full tank before beginning operation.

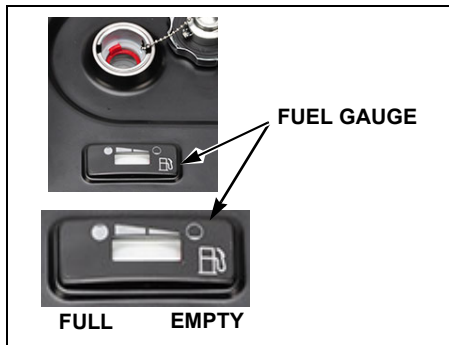

Check the fuel level with the generator on a level surface. Always refuel with the engine OFF and cool.

OPERATION

Safe Operating Instructions

Before operating the generator for the first time, review chapters GENERATOR SAFETY (page 2) and BEFORE EACH USE (page 5).

For your safety, do not operate the generator in an enclosed area such as a garage. Your generator's exhaust contains poisonous carbon monoxide gas that can collect rapidly in an enclosed area and cause illness or death.

⚠ WARNING

Exhaust contains poisonous carbon monoxide gas that can build up to dangerous levels in a closed area.

Breathing carbon monoxide can cause unconsciousness or death.

Never run the generator in a closed, or even partly closed area where people may be present.

Before connecting an AC appliance or power cord to the generator:

- Use grounded 3-prong extension cords, tools, and appliances, or double-insulated tools and appliances.
- Inspect cords and plugs, and replace if damaged.
- Make sure that the appliance is in good working order. Faulty appliances or power cords can create a potential for electric shock.
- Make sure the electrical rating of the tool or appliance does not exceed the rated power of the generator or the receptacle being used.
- Operate the generator at least 3 feet (1 meter) away from buildings and other equipment.
- Do not operate the generator in an enclosed structure.
- Do not place flammable objects close to the engine or locate the generator near flammable materials.

Starting the Engine

To prevent a possible fire, keep the generator at least 3 feet (1 meter) away from building walls and other equipment during operation. Do not place flammable objects close to the engine.

NOTICE

Operating this generator less than 3 feet (1 meter) from a building or other obstruction can cause overheating and damage the generator. For proper cooling, allow at least 3 feet (1 meter) of empty space above and around the generator.

Refer to GENERATOR SAFETY on page 2 and perform the BEFORE EACH USE checks (page 5). Refer to AC OPERATION (page 8) for connecting loads to the generator.

1. Make sure that all appliances are disconnected from the AC receptacles.
2. Turn the fuel valve lever to the ON position.

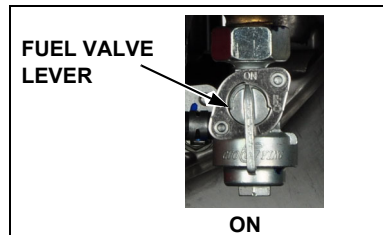

3. Make sure the Eco Throttle switch is in the OFF position, or more time will be required for warm-up.

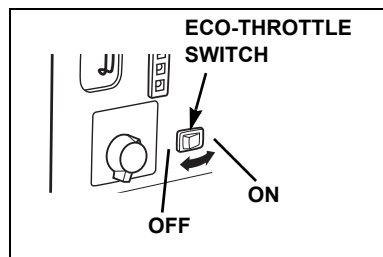

4. To start a cold engine, pull the choke rod out to the CLOSED position. To restart a warm engine, leave the choke rod in the OPEN position.

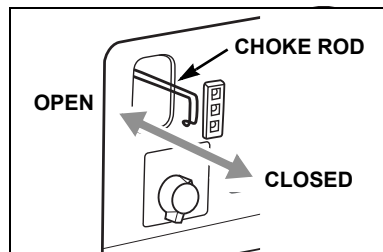

5. Turn the engine switch to the ON position.

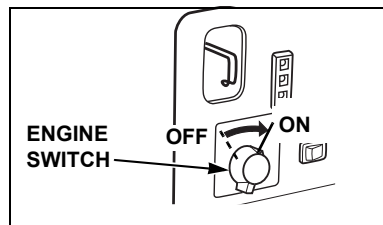

6. Pull the starter grip lightly until resistance is felt, then pull briskly.

NOTICE

Do not allow the starter grip to snap back against the engine. Return it gently to prevent damage to the starter.

Do not let the starter rope rub against the generator body, or the rope may wear out prematurely.

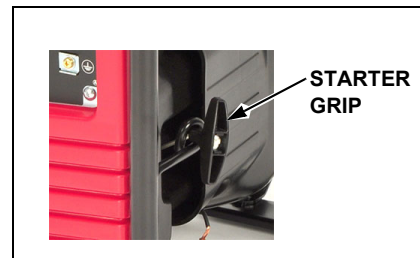

- If the choke rod was moved to the CLOSED position to start the engine, gradually push it to the OPEN position as the engine warms up.
- If you wish to use the Eco Throttle system, turn the Eco Throttle system switch to the ON position after the engine has warmed up for 2 or 3 minutes.

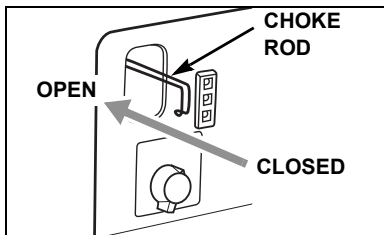

Stopping the Engine

To stop the engine in an emergency, simply turn the engine switch to the OFF position. Under normal conditions, use the following procedure.

- Turn off or disconnect all appliances that are connected to the generator.
- Turn the engine switch to the OFF position.

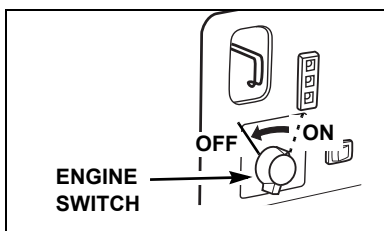

- Turn the fuel valve lever to the OFF position.

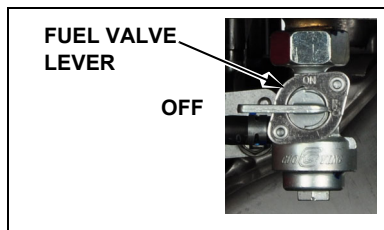

AC Operation

Before connecting an appliance(s) to the generator, make sure that it is in good working order and that the appliance(s) total electrical rating does not exceed that of the generator.

Most motorized appliances require more than their electrical rating for startup. When an electric motor is started, the overload alarm (red) may come on. This is normal if the overload alarm (red) goes off within nine seconds. If the overload alarm (red) stays on, consult your generator dealer.

NOTICE

Substantial overloading may damage the generator. Marginal overloading may shorten the service life of the generator.

- Start the engine ([page 7](#)) and make sure the output indicator (green) comes on.
- Plug in the appliance.
- Turn on the appliance.

If the generator is overloaded (in excess of 2.8 kVA), if there is a short circuit in a connected appliance, or if the inverter is overheated, the overload alarm (red) will come ON. The overload alarm (red) will stay ON, and after about 4~10 seconds, current to the connected appliance(s) will shut off, and the output indicator (green) will go OFF. Stop the engine and investigate the problem.

Determine if the cause is a short circuit in a connected appliance or an overload. Correct the problem and restart the generator.

AC Applications

Before connecting an appliance or power cord to the generator:

- Make sure that it is in good working order. A faulty appliance or power cord can create a potential for electrical shock.
- If an appliance begins to operate abnormally, becomes sluggish, or stops suddenly, turn it off immediately. Disconnect the appliance, and determine whether the problem is the appliance or if the rated load capacity of the generator has been exceeded.

Most appliance motors require more than their rated wattage for startup.

Make sure the electrical rating of the tool or appliance does not exceed the maximum power rating of the generator.

Maximum power is: 2.8 kVA

For continuous operation, do not exceed the rated power.

Rated power is: 2.5 kVA

In either case, the total power requirements (VA) of all appliances connected must be considered. Appliance and power tool manufacturers usually list rating information near the model number or serial number.

NOTICE

Substantial overloading that continuously lights the red overload alarm may damage the generator. Marginal overloading that temporarily lights the red overload alarm may shorten the service life of the generator.

Eco Throttle System

With the switch in the ON position, engine speed is automatically lowered when electrical loads are reduced, turned off, or disconnected. When appliances are turned on or reconnected, the engine returns to the proper speed to power the electrical load. In the OFF position, the Eco Throttle system does not operate and the engine runs at high speed.

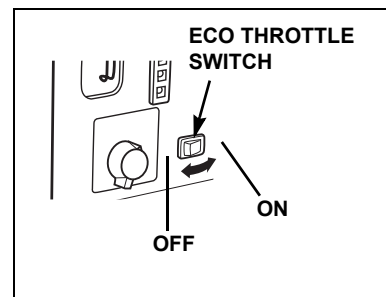

Appliances with large start-up power demands may not allow the engine to reach normal operating rpm when they are connected to the generator. Turn the Eco Throttle switch to the OFF position and connect the appliance to the generator. If the engine still will not reach normal operating speed, check that the appliance does not exceed the rated load capacity of the generator.

If high electrical loads are connected simultaneously, turn the Eco Throttle switch to the OFF position to reduce voltage changes.

The Eco Throttle system is not effective for use with appliances or tools that require only momentary power. If the tool or appliance will be turned ON and OFF quickly, the Eco Throttle switch should be in the OFF position.

Standby Power

Connections to a Building's Electrical System

Connections for standby power to a building's electrical system must be made by a qualified electrician. The connection must isolate the generator power from utility power, and must comply with all applicable laws and electrical codes.

⚠ WARNING

Improper connections to a building's electrical system can allow current from the generator to backfeed into the utility lines.

Such backfeed may electrocute utility company workers or others who contact the lines during a power outage, and the generator may explode, burn, or cause fires when utility power is restored.

Consult the utility company or a qualified electrician prior to making any power connections.

In some areas, generators are required by law to be registered with local utility companies. Check local regulations for proper registration and use procedures.

System Ground

This generator has a system ground that connects the generator frame components to the ground terminals in the AC output receptacles. The system ground is not connected to the AC neutral wire.

Special Requirements

NOTICE

Do not lay the generator on its side when moving, storing, or operating it. Oil may leak and damage the engine or your property.

There may be Federal or State Occupational Safety and Health Administration (OSHA) regulations, local codes, or ordinances that apply to the intended use of the generator. Please consult a qualified electrician, electrical inspector, or the local agency having jurisdiction.

- In some areas, generators are required to be registered with local utility companies.
- If the generator is used at a construction site, there may be additional regulations that must be observed.

SERVICING YOUR GENERATOR

The Importance of Maintenance

Good maintenance is essential for safe, economical, and trouble free operation. It will also help reduce air pollution.

To help you properly care for your generator, the following pages include a maintenance schedule, routine inspection procedures, and simple maintenance procedures using basic hand tools. Other service tasks that are more difficult or require special tools are best handled by professionals and are normally performed by a Honda technician or other qualified mechanic.

The maintenance schedule applies to normal operating conditions. If you operate your generator under unusual conditions, such as sustained high-load or high-temperature operation, or use it in dusty conditions, consult your servicing dealer for recommendations applicable to your individual needs and use.

⚠ WARNING

Improper maintenance, or failure to correct a problem before operation, can cause a malfunction in which you can be seriously hurt or killed.

Always follow the inspection and maintenance recommendations and schedules in this manual.

Remember that an authorized Honda servicing dealer knows your generator best and is fully equipped to maintain and repair it.

To ensure the best quality and reliability, use only new, Honda Genuine parts or their equivalents for repair and replacement.

Maintenance, replacement, or repair of the emission control devices and systems may be performed by any engine repair establishment or individual, using parts that are "certified" to EPA standards.

Maintenance Safety

Some of the most important safety precautions follow. However, we cannot warn you of every conceivable hazard that can arise in performing maintenance. Only you can decide whether or not you should perform a given task.

⚠ WARNING

Failure to properly follow maintenance instructions and precautions can cause you to be seriously hurt or killed.

Always follow the procedures and precautions in the owner's manual.

Safety Precautions

Make sure the engine is off before you begin any maintenance or repairs. This will eliminate several potential hazards:

- Carbon monoxide poisoning from engine exhaust.
Be sure there is adequate ventilation whenever you operate the engine.
- Burns from hot parts.
Let the engine and exhaust system cool before touching.
- Injury from moving parts.
Do not run the engine unless instructed to do so.
- Read the instructions before you begin, and make sure you have the tools and skills required.
- To reduce the possibility of fire or explosion, be careful when working around gasoline. Use only a non-flammable solvent, not gasoline, to clean parts. Keep cigarettes, sparks, and flames away from all fuel-related parts.

Maintenance Schedule*

Item	Action	Before each use	5 hours of use or first month	25 hours of use or every 3 months	50 hours of use or every 6 months	100 hours of use or every year	250 hours of use or every 2 years	See page
Engine oil	Check level	○						11
	Change		○		○ (2)			
Air cleaner	Check	○						12
	Clean			○ (1)	○ (1)	○ (1)		
	Replace						○	
Sediment cup	Clean					○		13
Spark plug	Check-adjust					○		12
	Replace						○	
Spark arrester	Clean					○		13
Valve clearance	Check-adjust						○(3)	—
Combustion chamber	Clean	After every 250 hrs (3)						—
Timing belt	Check	After every 250 hrs (3)						—
Fuel tank/filter	Clean						○(3)	—
Fuel tube	Check	Check every 2 years and replace if necessary (3)						—
EVAP Canister	Check	Check every 2 years and replace if necessary (3)						—
Purge tube	Check	Check every 2 years and replace if necessary (3)						—
Charge tube	Check	Check every 2 years and replace if necessary (3)						—

* For commercial use, log hours of operation to determine proper maintenance intervals.

(1) Service more frequently when used in dusty areas.

(2) Change engine oil every 25 hours when used under heavy load or in high outside air temperatures.

(3) These items should be serviced by an authorized Honda servicing dealer unless you have the proper tools and are mechanically proficient.

Refer to the Honda shop manual for service procedures. See "Honda Publications" on [page 19](#) for ordering information.

Failure to follow this Maintenance Schedule could result in non-warrantable failures.

Refueling

With the engine stopped, remove the fuel tank cap and check the fuel level. Refill the fuel tank if the fuel level is low. Turn the fuel valve OFF (page 6).

⚠ WARNING

Gasoline is highly flammable and explosive.

You can be burned or seriously injured when handling fuel.

- Stop the engine and let it cool before refueling
- Keep heat, sparks, and flame away
- Refuel only outdoors
- Wipe up spills immediately

NOTICE

Fuel can damage paint and plastic. Be careful not to spill fuel when filling your fuel tank. Damage caused by spilled fuel is not covered under the DISTRIBUTOR'S LIMITED WARRANTY.

- Refuel in a well-ventilated area before starting the engine. If the engine has been running, allow it to cool. Refuel carefully to avoid spilling fuel.
- Do not fill the fuel tank above the upper level mark (page 4) or fuel may flow into the EVAP canister causing fuel spillage.
- Never refuel the engine inside a building where gasoline fumes may reach flames or sparks.
- Keep gasoline away from appliance pilot lights, barbecues, electric appliances, power tools, etc.
- Spilled fuel is not only a fire hazard, it causes environmental damage. Wipe up spills immediately.

Fuel Recommendations

This engine is certified to operate on regular unleaded gasoline with a pump octane rating of 86 or higher.

Never use gasoline that is stale, contaminated, or mixed with oil. Avoid getting dirt or water in the fuel tank.

You may use regular unleaded gasoline containing no more than 10% ethanol (E10) or 5% methanol by volume. In addition, methanol must contain co-solvents and corrosion inhibitors.

Use of fuels with a content of ethanol or methanol greater than shown above may cause starting and/or performance problems. It may also damage metal, rubber, and plastic parts of the fuel system.

Engine damage or performance problems that result from using a fuel with percentages of ethanol or methanol greater than shown above are not covered under the DISTRIBUTOR'S LIMITED WARRANTY.

If your equipment will be used on an infrequent or intermittent basis, please refer to the fuel section of the STORAGE chapter (page 13) for additional information regarding fuel deterioration.

Engine Oil Level Check

Check the oil level BEFORE EACH USE with the generator on a level surface and the engine stopped.

1. Remove the oil filler cap/dipstick and wipe it with a clean towel.
2. Check the oil level. If it is below the upper limit, fill with the recommended oil (page 12) to the upper limit of the oil filler neck.
3. Reinstall the oil filler cap securely.

The Oil Alert® system will automatically stop the engine before the oil level falls below safe limits. However, to avoid the inconvenience of an unexpected shutdown, check the oil level regularly.

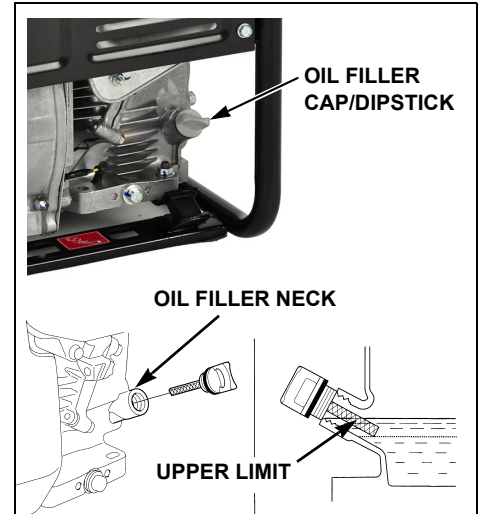

Engine Oil Change

Drain the oil while the engine is warm to assure rapid and complete draining.

1. Place the generator on a level surface.
2. Place a suitable container below the engine to catch the oil, then remove the drain plug and sealing washer, remove the oil filler cap, and drain the oil.
3. Reinstall the oil drain plug and a new sealing washer. Tighten the plug securely.
4. Refill with the recommended oil (page 12) and check the oil level. **Approximate refill amount: 15.0 ~ 16.0 oz (0.44 ~ 0.47 L)**
5. Reinstall the oil filler cap/dipstick and tighten it securely.

Wash your hands with soap and water after handling used oil.

NOTICE

Using non detergent oil can shorten the engine's service life, and using 2-stroke oil can damage the engine.

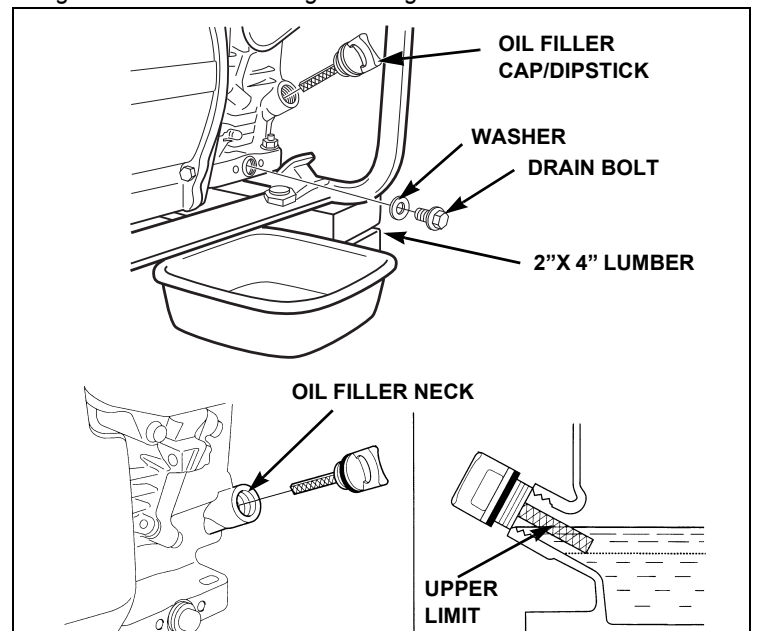

Engine Oil Recommendations

Oil is a major factor affecting performance and service life. Always change the oil in accordance with the *Maintenance Schedule* (page 10).

Recommended oil for general use: SAE 10W-30

Other viscosities shown in the chart may be used when the average temperature in your area is within the recommended range.

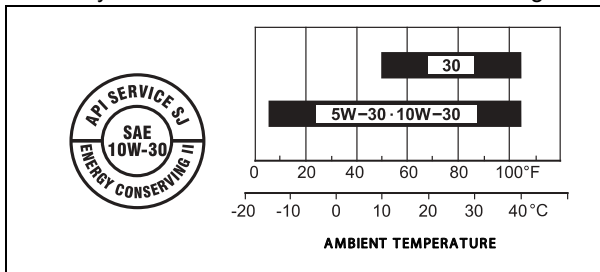

The SAE oil viscosity and service category are in the API label on the oil container. Honda recommends API service category SJ or later oil.

Air Cleaner

Clean the air filter after the first 25 hours of use. Thereafter, clean the filter every 6 months or 50 hours of use. Clean the filter more often when used in dusty areas. Replace the filter every 2 years or 250 hours of use. See page 10 for the complete maintenance schedule.

A properly maintained air filter will help prevent dirt from entering your engine. Dirt entering the carburetor can be drawn into small passages in the carburetor and cause premature engine wear. These small passages can become blocked, causing starting or running problems.

Operating the engine without an air filter, with a damaged air filter, or with an improperly installed air cleaner cover will allow dirt to enter the engine, causing rapid engine wear. This type of damage is not covered by the DISTRIBUTOR'S LIMITED WARRANTY (page 20).

We recommend the use of a Honda Genuine air filter to ensure it seals and performs as designed. Using a non-Honda air filter can result in dirt bypassing the filter, causing damage to the engine or fuel system.

1. Press down on the cover tabs and remove the cover.
2. Remove the filters from the air cleaner housing.

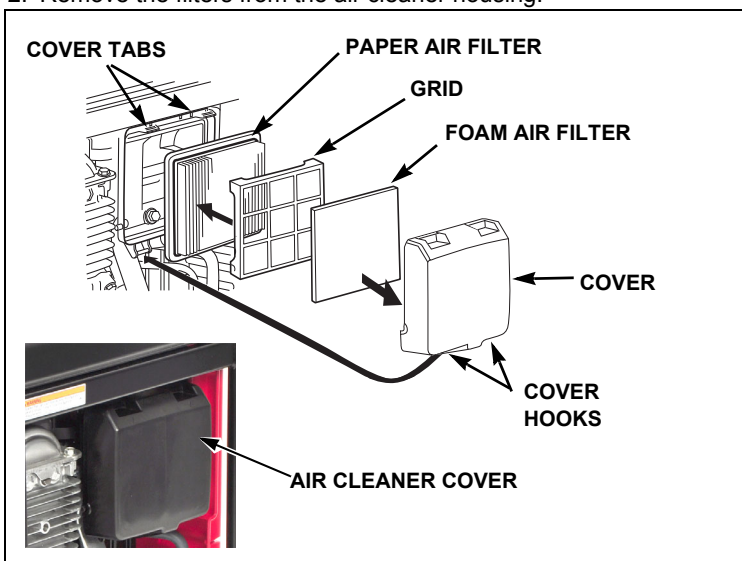

3. Inspect the filters; replace if damaged.
4. Paper Air Filter: Clean the paper filter by tapping it several times on a hard surface to remove dirt, or blow compressed air (not exceeding 30 psi [207 kPa]) through the air filter from the inside. Never try to brush off dirt; brushing will force dirt into the fibers.

5. Foam Air Filter: Wash the foam air filter in a solution of household detergent and warm water, then rinse thoroughly, or wash in non-flammable or high flash point solvent. Allow the foam air filter to dry thoroughly.

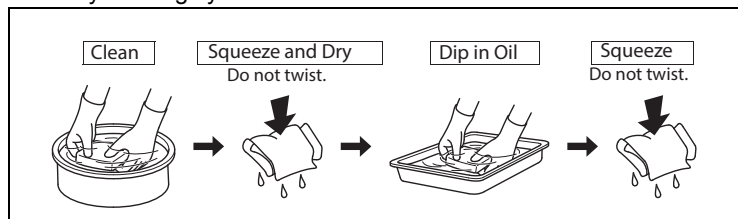

6. Wipe dirt from the inside of the air cleaner housing and cover using a moist rag. Be careful to prevent dirt from entering the air duct that leads to the carburetor.
7. Reinstall the filters, grid, and cover as shown. Be sure both tabs are fully locked in place.

Spark Plug

Replace the spark plug every 2 years or after 250 hours of use.

Required Spark Plug: NGK - BPR6ES

An incorrect spark plug can cause engine damage.

For good performance, the spark plug must be properly gapped and free of deposits.

1. Allow the engine to cool, disconnect the spark plug cap, and remove any dirt from around the spark plug area.
2. Remove the spark plug with a 13/16 in (21 mm) spark plug wrench.
3. Inspect the spark plug. Replace it if the electrodes are worn, or if the insulator is cracked or chipped.
4. Measure the spark plug electrode gap with a suitable gauge.

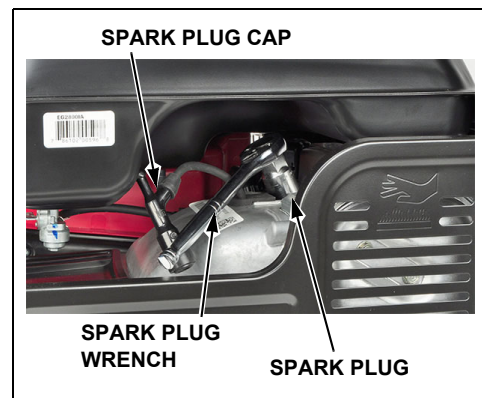

Gap: 0.028 ~ 0.031 in (0.7 ~ 0.8 mm)
Correct the gap, if necessary, by carefully bending the side electrode.

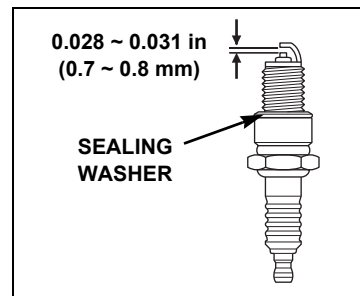

5. Install the spark plug carefully, by hand, to avoid cross-threading.
6. After the spark plug seats, tighten with a 13/16 in (21 mm) spark plug wrench to compress the washer.
 - If reinstalling the old spark plug, tighten 1/8 to 1/4 turn after the spark plug seats.
 - If installing a new spark plug, tighten 1/2 turn after the spark plug seats.

Spark plug torque: 14 ft-lb (20 N·m)

NOTICE

A loose spark plug can overheat and damage the engine. Overtightening the spark plug can damage the threads in the cylinder head.

7. Install the spark plug cap onto the spark plug.

Sediment Cup Cleaning

The sediment cup prevents water that may be in the fuel tank from entering the carburetor. If the engine has not been run for a long time, the sediment cup should be cleaned.

1. Turn the engine switch to the OFF position.
2. Turn the fuel valve lever to the OFF position.
3. Unscrew the sediment cup using a 10mm wrench and remove the o-ring and filter.

⚠ WARNING

Gasoline is highly flammable and explosive.

You can be burned or seriously injured when handling fuel.

- Stop the engine and let it cool before refueling
- Keep heat, sparks, and flame away
- Refuel only outdoors
- Wipe up spills immediately

4. Clean the sediment cup and filter in a non-flammable or high flash point solvent.
5. Install the filter by aligning it with the fuel inlet.
6. Install the new o-ring and sediment cup. Tighten securely.
7. Turn the fuel valve lever to the ON position and check for leaks.

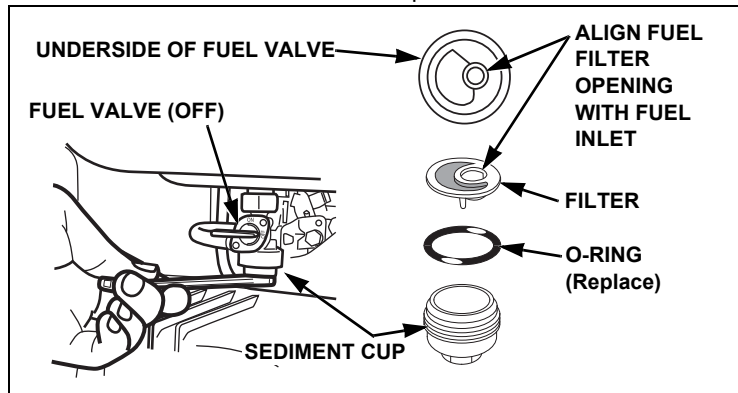

Spark Arrester

The spark arrester must be serviced every 100 hours to keep it functioning as designed.

1. Allow the engine to cool and disconnect the spark plug cap.
2. Remove the 4mm self-tapping screw and the spark arrester from the muffler.
3. Check for carbon deposits on the spark arrester and the exhaust port. Use a brush to remove any carbon deposits from the screen. Replace the screen if it is torn or damaged.
4. Installation is the reverse of removal. Tighten all hardware securely.

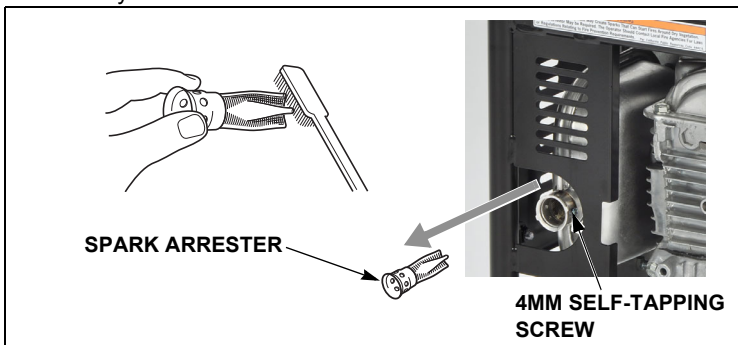

TRANSPORTING

If the engine has been running, allow it to cool for at least 15 minutes before loading the generator on the transport vehicle. A hot engine and exhaust system can burn you and can ignite some materials.

Turn the fuel valve lever to the OFF position. This will prevent carburetor flooding and reduce the possibility of fuel leakage.

Two people should lift the generator on and off the transport vehicle while holding the generator level.

Position the generator so that its base is level on the bed of the transport vehicle. Tie the generator down with rope or straps. Keep the tie-down rope or straps away from the controls.

Do not operate the generator while it is being transported or while it is mounted to any type of vehicle, trailer, or boat.

STORAGE

Proper storage preparation is essential for keeping your generator trouble free and looking good. To help keep rust and corrosion from impairing your generator's function and appearance, and to make the engine easier to start after storage, follow the instructions described in this section to:

- Drain or treat the fuel
- Change the oil and coat the engine cylinder
- Clean the generator
- Choose a storage location

Fuel

See "AVOIDING FUEL-RELATED PROBLEMS" on [page 18](#) for a list of recommended procedures to avoid fuel related problems.

The *DISTRIBUTOR'S LIMITED WARRANTY* ([page 20](#)) does not cover fuel system damage or engine performance problems resulting from neglected storage preparation.

Draining the Carburetor

1. Place a suitable gasoline container below the carburetor.
2. Turn the fuel valve lever to the OFF position, loosen the carburetor drain bolt by turning 1 to 2 turns counterclockwise, and drain the fuel from the carburetor into a suitable container.
3. After all the fuel has drained into the container, tighten the carburetor drain bolt securely.
4. Turn the fuel valve lever to the OFF position.

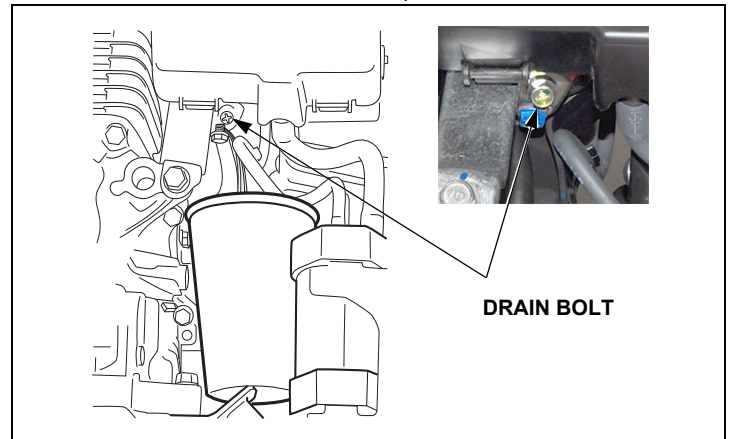

Draining the Fuel Tank

1. Place a suitable container below the sediment cup.
2. Turn the fuel valve lever to the OFF position.
3. Remove the sediment cup (page 13), and then turn the fuel valve lever to the ON position to drain the fuel from the fuel tank.
4. Install the sediment cup and a new O-ring.
5. Turn the fuel valve lever to the OFF position.

Cleaning

Wipe the generator with a moist cloth. After the generator has dried, touch up any damaged paint, and coat other areas that may rust with a light film of oil.

Oil

Change the engine oil (see page 11). Add oil in the engine cylinder to prevent corrosion.

1. Remove the spark plug (page 12).

2. Pour a teaspoon (5 cc) of clean engine oil into the cylinder to keep it from rusting.

3. Pull the starter rope several times to distribute the oil in the cylinder.

4. Reinstall the spark plug.

5. Pull the starter rope slowly until resistance is felt, and then return the starter grip gently. This will close the valves so moisture cannot enter the engine cylinder.

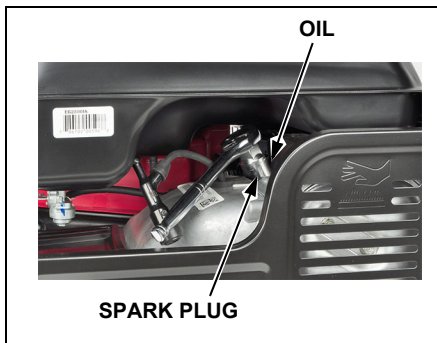

Storage Location

If your generator will be stored with gasoline in the fuel tank and carburetor, it is important to reduce the hazard of gasoline vapor ignition. Select a well-ventilated dry storage area away from any appliance that operates with a flame, such as a furnace, water heater, or clothes dryer. Also avoid any area with a spark-producing electric motor, or where power tools are operated.

Make sure the fuel valve is in the OFF position to reduce the possibility of fuel leakage.

Place the generator on a level surface. Tilting can cause fuel or oil leakage.

With the engine and exhaust system cool, cover the generator to keep out dust. A hot engine and exhaust system can ignite or melt some materials. Do not use sheet plastic as a dust cover. A nonporous cover will trap moisture around the generator, promoting rust and corrosion.

Removing from Storage

Check your generator as described in "BEFORE EACH USE" on page 5.

If the engine cylinder was coated with oil during storage preparation, the engine may smoke briefly at startup.

TROUBLESHOOTING

Engine Will Not Start

Possible Cause	Correction
Fuel valve lever OFF	Turn the fuel valve level ON (page 6).
Out of fuel	Refuel (page 11).
Bad fuel; generator stored without treating gasoline, or refueled with bad gasoline	Refuel with fresh gasoline (page 18).
Low oil level caused Oil Alert to stop engine	Check oil level (page 11). Add oil as necessary. Turn the engine switch OFF and then ON and restart the engine.
Spark plug faulty, fouled, or improperly gapped	Gap or replace the spark plug (page 12).
Spark plug wet with fuel (flooded engine)	Dry and reinstall the spark plug.
Fuel filter clogged, carburetor malfunction, ignition malfunction, valves stuck, etc.	Take the generator to an authorized Honda servicing dealer for repair.

Loss of Power

Possible Cause	Correction
Air filter is clogged	Clean or replace the air filter (page 12).
Bad fuel; generator stored without treating gasoline, or refueled with bad gasoline	Refuel with fresh gasoline (page 18).
Fuel filter clogged, carburetor malfunction, ignition malfunction, valves stuck, etc.	Take the generator to an authorized Honda servicing dealer for repair.

No Power at the AC Receptacles

Possible Cause	Correction
Output indicator is OFF, and the overload alarm is ON	Check the AC load. Stop and restart the engine. (page 8).
	Check the cooling air inlet. Stop and restart the engine.
AC circuit protector is tripped	Check the AC load and reset the circuit protector. (page 8).
Faulty power tool or appliance	Replace or repair the power tool or appliance. Stop and restart the engine.
Faulty generator	Take the generator to an authorized Honda servicing dealer, or refer to the shop manual. (page 19).

TECHNICAL INFORMATION

Serial Number Locations



There are two serial numbers, one for the engine and one for the generator frame. Record the engine and frame serial numbers in the spaces below. You will need these serial numbers when ordering parts and when making technical or warranty inquiries.

Frame serial number: EABA-_____

Engine serial number: GCAAA-_____

Date of purchase: _____

High Altitude Operation

At high altitudes, the standard carburetor air-fuel mixture will be too rich. Performance will decrease, and fuel consumption will increase. A very rich mixture will also foul the spark plug and cause hard starting. Operation at an Altitude that differs from that at which this engine was certified, for extended periods of time, may increase emissions.

High altitude performance can be improved by specific modifications to the carburetor. If you always operate your generator at altitudes above 2,000 feet (610 meters), have your servicing dealer perform this carburetor modification. This engine, when operated at high altitude with the carburetor modifications for high altitude use, will meet each emission standard throughout its useful life.

Even with carburetor modification, engine horsepower will decrease about 3.5% for each 1,000-foot (300-meter) increase in altitude. The effect of altitude on horsepower will be greater than this if no carburetor modification is made.

NOTICE

When the carburetor has been modified for high altitude operation, the air-fuel mixture will be too lean for low altitude use. Operation at altitudes below 2,000 feet (610 meters) with a modified carburetor may cause the engine to overheat and result in serious engine damage. For use at low altitudes, have your servicing dealer return the carburetor to original factory specifications.

Emission Control System

Source of Emissions

The combustion process produces carbon monoxide, oxides of nitrogen, and hydrocarbons. Control of hydrocarbons and oxides of nitrogen is very important because, under certain conditions, they react to form photochemical smog when subjected to sunlight. Carbon monoxide does not react in the same way, but it is toxic.

Honda utilizes appropriate air/fuel ratios and other emissions control systems to reduce the emissions of carbon monoxide, oxides of nitrogen, and hydrocarbons. Additionally, Honda fuel systems utilize components and control technologies to reduce evaporative emissions.

U.S. and California Clean Air Acts

U.S. EPA and California regulations require all manufacturers to furnish written instructions describing the operation and maintenance of emissions control systems.

The following instructions and procedures must be followed in order to keep the emissions from your Honda engine within the emissions standards.

Tampering and Altering

NOTICE

Tampering is a violation of federal and California law.

Tampering with or altering the emissions control system may increase emissions beyond the legal limit. Among those acts that constitute tampering are:

- Removal or alteration of any part of the intake, fuel, or exhaust systems
- Altering or defeating the speed-adjusting mechanism to cause the engine to operate outside its design parameters

Problems That May Affect Emissions

If you are aware of any of the following symptoms, have your engine inspected and repaired by your servicing dealer.

- Hard starting or stalling after starting
- Rough idle
- Misfiring, backfiring under load, or afterburning
- Black exhaust smoke or high fuel consumption

Replacement Parts

The emissions control systems on your new Honda engine were designed, built, and certified to conform with EPA and California emissions regulations. We recommend the use of Honda Genuine parts whenever you have maintenance done. These original-design replacement parts are manufactured to the same standards as the original parts, so you can be confident of their performance. Honda cannot deny coverage under the emission warranty solely for the use of non-Honda replacement parts or service performed at a location other than an authorized Honda dealership; you may use comparable EPA certified parts, and have service performed at non-Honda locations. However, the use of replacement parts that are not of the original design and quality may impair the effectiveness of your emissions control system.

A manufacturer of an aftermarket part assumes the responsibility that the part will not adversely affect emissions performance. The manufacturer or rebuilder of the part must certify that use of the part will not result in a failure of the engine to comply with emissions regulations.

Maintenance

As the power equipment engine owner, you are responsible for completing all required maintenance listed in your owner's manual. Honda recommends that you retain all receipts covering maintenance on your power equipment engine, but Honda cannot deny warranty coverage solely for the lack of receipts or for your failure to ensure that all scheduled maintenance has been completed.

Follow the Maintenance Schedule on [page 10](#). Remember this schedule is based on the assumption that your machine will be used for its designed purpose. Sustained high-load or high-temperature operation, or use in unusually wet or dusty conditions, will require more frequent service.

Air Index

An Air Index Information hang tag/label is applied to engines certified to an emission durability time period in accordance with the requirements of the California Air Resources Board.

The bar graph is intended to provide you, our customer, the ability to compare the emissions performance of available engines. The lower the Air Index, the less pollution.

The durability description is intended to provide you with information relating the engine's emission durability period. The descriptive term indicates the useful life period for the engine's emission control system. See your *EMISSION SYSTEM WARRANTY* ([page 21](#)) for additional information.

Descriptive Term	Applicable to Emissions Durability Period
Moderate	50 hours (0 ~ 80 cc) 125 hours (greater than 80 cc)
Intermediate	125 hours (0 ~ 80 cc) 250 hours (greater than 80 cc)
Extended	300 hours (0 ~ 80 cc) 500 hours (greater than 80 cc) 1000 hours (225 cc and greater)

Specifications

Generator Features

EG2800i	Lightweight inverter generator with Eco Throttle®
---------	---

Dimensions and Weights

Length	16.9 in (430 mm)
Width	17.6 in (448 mm)
Overall height	18.9 in (481 mm)
Dry weight	66.6 lbs (30.2 kg)

Engine Design and Performance

Model	GC190
Type	4-stroke, overhead-cam, single-cylinder, air-cooled
Displacement	11.4 cu in (186 cc)
Bore and stroke	2.71 x 1.97 in (69.0 x 50.0 mm)
Compression ratio	8.5:1
Ignition system	Transistorized magneto

Generator

Type	A type	
AC output	Rated voltage	120V
	Rated frequency	60 Hz
	Rated current	20.8 A
	Rated output	2.5 kVA
	Maximum output	2.8 kVA

Maintenance

Fuel	Unleaded gasoline with a pump octane rating of 86 or higher containing no more than 10% ethanol by volume Capacity: 2.14 US gal (8.1 L) See "AVOIDING FUEL-RELATED PROBLEMS" on page 18	page 11
Engine Oil	SAE 10W-30, API SJ or later Capacity: 19.6 oz (0.58 L) Approx. refill amount: 15.0 ~ 16.0 oz (0.44 ~ 0.47 L)*	page 12
Spark Plug	Type: NGK - BPR6ES Gap: 0.028 ~ 0.031 in (0.7 ~ 0.8 mm)	page 12
Valve clearance (cold)	Intake: 0.15 ± 0.04 mm Exhaust: 0.20 ± 0.04 mm	Shop manual

* Actual amount will vary due to residual oil in the engine. Always use the dipstick to confirm the actual level ([page 11](#)).

Wiring Diagram

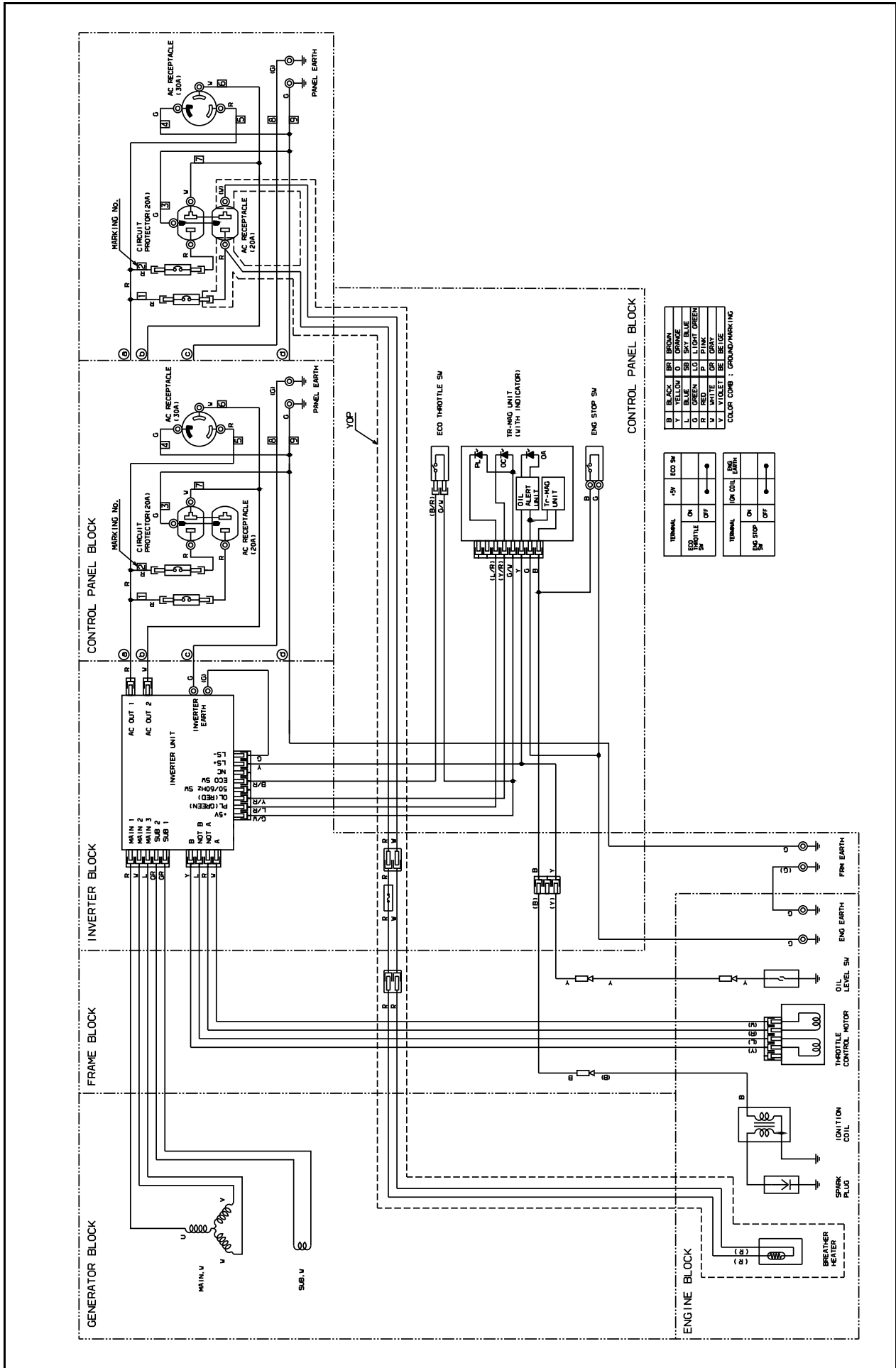

AVOIDING FUEL-RELATED PROBLEMS

When properly maintained, your Honda generator should provide years of trouble-free operation. This includes the fuel system. However, gasoline can quickly deteriorate (in as little as 30 days) causing starting or running problems and, in some cases, damage to the fuel system. Most fuel-related problems can be avoided by following the precautions listed below. Fuel system damage and engine performance problems resulting from deteriorated gasoline are not covered by the *DISTRIBUTOR'S LIMITED WARRANTY* ([page 20](#)).

Follow These Precautions to Prevent Most Fuel-Related Problems

During the Normal Use	Reason
Do not use gasoline containing more than 10% ethanol (E10). Not all automotive gasoline is safe to use in your generator.	Higher levels of ethanol in gasoline attract water, and can corrode or damage the fuel system and cause performance problems.
Store gasoline in a clean, plastic, sealed container approved for fuel storage. Store your fuel supply container away from direct sunlight; if the container has a vent, keep it closed.	A plastic container eliminates the risk of rust and metallic contaminants from a metal container entering the fuel system. Gasoline will deteriorate faster when exposed to air and sunlight.
Purchase only enough gasoline to last for 1 to 2 months (about 30 to 60 days). If you purchase enough gasoline to last for more than 60 days, add a fuel stabilizer to your storage container when you fill it.	Gasoline deteriorates with age so try to avoid storing it for long periods, especially in summer heat. Fuel stabilizer will extend the shelf life of gasoline, but it will not reconstitute stale fuel.
Keep your generator's fuel tank full of fresh fuel when not in use. Turn the fuel valve OFF.	If the fuel tank is only partially filled, air in the tank will promote fuel deterioration.
Keep the air filter clean and properly serviced. Check it before each use.	A properly maintained air filter will help prevent dirt from entering the carburetor. The small passages inside the carburetor can become blocked.
3 to 4 Weeks Before Next Use	Reason
Keep your generator's fuel tank full of fresh fuel when not in use. Turn the fuel valve OFF.	If the fuel tank is only partially filled, air in the tank will promote fuel deterioration.
Turn the fuel valve to the OFF position, start the engine and let it run approximately 3 minutes until the carburetor is empty and the engine stops.	The small amount of gasoline in your engine's carburetor will deteriorate faster than the fuel in the fuel tank due to its small volume and heat from the engine.
1 to 3 Months Before Next Use	Reason
If you did not add fuel stabilizer to your fuel storage container when you filled it up, fill your generator's fuel tank with fresh gasoline.	If the fuel tank is only partially filled, air in the tank will promote fuel deterioration.
Add fuel stabilizer to the generator's fuel tank according to the stabilizer manufacturer's instructions.	Fuel stabilizer will extend the life of gasoline, but it will not reconstitute stale gasoline.
Run the engine outdoors for 10 minutes.	This makes sure treated gasoline has replaced untreated gasoline throughout the fuel system.
Turn the fuel valve to the OFF position, start the engine, and let it run approximately 3 minutes until the carburetor is empty and the engine stops.	The small amount of gasoline in your engine's carburetor will deteriorate faster than the fuel in the fuel tank due to its small volume and heat from the engine.
More Than 3 Months Before Next Use	Reason
Remove the fuel from the carburetor and fuel tank (page 13 .) Do not allow gasoline to remain in your generator's fuel tank for more than 3 months (about 90 days) of inactivity.	All fuel stabilizers have a shelf life. It is good practice to empty the fuel system for long term inactivity.

We recommend Pro Honda Fuel Stabilizer that has an improved formulation with added corrosion protection ([page 19](#)).

CUSTOMER INFORMATION

Parts, Service Items & Accessories

Contact an authorized Honda servicing dealer to purchase any of these (or other) Honda Genuine items for your generator.

Replacement Parts

Item	Part Number	Notes
Spark plug	98079-56846	NGK (brand) BPR6ES
Air filter	17211-Z8B-901	Paper
	17218-Z2A-000	Foam

Service Items

Item	Part Number	Notes
SAE 10W-30 engine oil	08207-10W30	1 quart
NO-SPILL [®] gas cans	06176-1415-C6	1-1/4 gallon
	06176-1405-C6	2-1/2 gallon
Fuel stabilizer	08732-0800	8 ounces For short and long term storage

NO-SPILL[®] is a registered trademark of NoSpill LLC.

Accessories

Please contact your servicing Honda dealer or visit powerequipment.honda.com/generators/accessories for available accessories.

Dealer Locator Information

To find an Authorized Honda Servicing Dealer anywhere in the United States:

Visit powerequipment.honda.com and click on Find a Dealer.

How to Contact Honda

Honda Power Equipment dealership personnel are trained professionals. They should be able to answer any question you may have. If you encounter a problem that your dealer does not solve to your satisfaction, please discuss it with the dealership's management. The Service Manager or General Manager can help. Almost all problems are solved in this way.

If you are dissatisfied with the decision made by the dealership's management, contact the Honda Power Equipment Customer Relations Office. You can write:

American Honda Motor Co., Inc.
Power Equipment Division
Customer Relations Office
4900 Marconi Drive
Alpharetta, GA 30005-8847

Or telephone: (770) 497-6400 M-F, 8:30 a.m. - 7:00 p.m. ET

When you write or call, please give us this information.

- Model and serial numbers ([page 15](#))
- Name of the dealer who sold the generator to you
- Name and address of the dealer who services your generator
- Date of purchase
- Your name, address, and telephone number
- A detailed description of the problem

Honda Publications

These publications will give you information for maintaining and repairing your generator.

Owner's Manual

Keep this owner's manual handy so you can refer to it at any time. Consider this owner's manual a permanent part of the generator; please give it to the new owner if you resell the generator.

An electronic, color version of the owner's manual is available for download by visiting powerequipment.honda.com and clicking on SUPPORT and then Owner's manuals, or you can click the Owners Manuals link provided at the bottom of the home page.

The information and specifications included in this publication were in effect at the time of approval for printing. American Honda Motor Co., Inc. reserves the right, however, to discontinue or change specifications or design at any time without notice and without incurring any obligation whatever. No part of this publication may be reproduced without written permission.

Shop Manual

This manual covers complete maintenance and overhaul procedures. It is intended to be used by a skilled technician. Available through your Honda dealer or visit powerequipment.honda.com and click on Product Support; then click on Shop Manuals.

Parts Catalog

This manual provides complete, illustrated parts lists for your generator. Visit peparts.honda.com for free online access to the parts catalog. It is also available for purchase in paper form through your Honda dealer.

Frequently Asked Questions



The Honda Power Equipment web site provides additional information for users of Honda power equipment. Visit powerequipment.honda.com and click on FAQs or scan the QR code shown.

DISTRIBUTOR'S LIMITED WARRANTY

Honda Power Equipment

This warranty is limited to the following Honda Power Equipment products when distributed by American Honda Motor Co., Inc., Power Equipment Division, 4900 Marconi Drive, Alpharetta, Georgia 30005-8847, purchased at retail or placed in rental service on or after January 1, 2010.

PRODUCTS COVERED BY THIS WARRANTY	LENGTH OF WARRANTY (from date of original retail purchase)	
	PRIVATE RESIDENTIAL ⁽¹⁾	COMMERCIAL/RENTAL/ INSTITUTIONAL
EG2800i	36 months	12 months

(1) Private residential: Used in maintaining owner's primary and/or secondary residence. Any other use, including but not limited to informal "for hire" use, is considered commercial/rental/institutional use.

To Qualify for This Warranty:

The product must be purchased in the United States, Puerto Rico, or the U.S. Virgin Islands from American Honda or a dealer authorized by American Honda to sell those products. This warranty applies to the first retail purchaser and each subsequent owner during the applicable warranty time period, unless noted otherwise.

What American Honda Will Repair or Replace Under Warranty:

American Honda will repair or replace, at its option, any part that is proven to be defective in material or workmanship under normal use during the applicable warranty time period. Warranty repairs and replacements will be made without charge for parts or labor. Anything replaced under warranty becomes the property of American Honda Motor Co., Inc. All parts replaced under warranty will be considered as part of the original product, and any warranty on those parts will expire coincident with the original product warranty.

To Obtain Warranty Service:

You must, at your expense, take the Honda Power Equipment product, accessory, replacement part, apparel, or the power equipment on which the accessory or replacement part is installed, and proof of purchase to any Honda Power Equipment dealer in the United States, Puerto Rico, or the U.S. Virgin Islands who is authorized to sell and/or service that product, during the dealer's normal business hours. To locate a dealer near you, visit our web site at PowerEquipment.Honda.com and click on Find a Dealer.

If you are unable to obtain warranty service or are dissatisfied with the warranty service you receive, contact the owner of the dealership involved; normally this will resolve the problem. However, if you should require further assistance, write or call the Power Equipment Customer Relations Dept. of American Honda Motor Co., Inc. See "How to Contact Honda" on [page 19](#).

Exclusions:

- Any damage or deterioration resulting from the following:
 - Neglect of the periodic maintenance as specified in this manual
 - Improper repair or maintenance
 - Operating methods other than those indicated in the product owner's manual
 - Increasing engine speed beyond factory specification
 - The use of non-genuine Honda parts, accessories, lubricants, and fluids other than those approved by Honda
 - Exposure of the product to soot and smoke, chemical agents, bird droppings, sea water, salt or other corrosive environments
 - Collision, fuel contamination or deterioration, neglect, unauthorized alteration, misuse, incorporation or use of unsuitable attachments or parts
 - Normal wear and tear (including but not limited to normal fading of painted or plated surfaces, sheet peeling and other natural deterioration)
- Consumable parts: Honda does not warrant parts deterioration due to normal wear and tear. The parts listed below are not covered by this warranty (unless they are needed during another repair covered under this warranty):
 - Spark plug, fuel filter, air cleaner element, clutch disc, tire, wheel bearing, recoil starter rope, cable, belt, cutter blade, oil and grease.
- Cleaning, adjustment, and normal periodic maintenance work (carburetor cleaning, engine oil draining, blade sharpening, belt and cable adjustments).
- Any product that has ever been declared a total loss or sold for salvage by a financial institution or insurer.
- Auger and paddle assemblies of snow throwers, tiller tines of roto-tillers, and mower blades and mower deck housings are specifically not warranted against impact damage, including but not limited to, abrasive damage.

Disclaimer of Consequential Damage and Limitation of Implied Warranties:

American Honda disclaims any responsibility for loss of time or use of the product, transportation, commercial loss, or any other incidental or consequential damage. Any implied warranties are limited to the duration of this written limited warranty. Some states do not allow limitations on how long an implied warranty lasts and/or do not allow the exclusion or limitation of incidental or consequential damages, therefore the above exclusions and limitations may not apply to you. This warranty gives you specific legal rights, and you may also have other rights which vary from state to state.

Honda Parts, Accessories, and Apparel

This warranty is limited to Honda Power Equipment parts, accessories, and apparel when distributed by American Honda Motor Co., Inc., 4900 Marconi Drive, Alpharetta, Georgia 30005-8847.

PRODUCTS COVERED BY THIS WARRANTY	LENGTH OF WARRANTY (from date of original retail purchase)	
	PRIVATE RESIDENTIAL	COMMERCIAL/ RENTAL/ INSTITUTIONAL
Parts	6 months	3 months
Accessories	12 months	3 months
Apparel	6 months	3 months

To Qualify for This Warranty:

- The parts, accessories, or apparel must be purchased from American Honda or a dealer authorized by American Honda to sell those products in the United States, Puerto Rico, and the U.S. Virgin Islands. Parts and Accessories must be purchased for installation on original Honda equipment or engines to be eligible for warranty coverage. Installing parts and accessories on non-Honda products or engines voids this warranty.
- You must be the first retail purchaser. This warranty is not transferable to subsequent owners.

What American Honda Will Repair or Replace Under Warranty:

American Honda will repair or replace, at its option, any Honda Power Equipment parts, accessories, replacement parts, or apparel that are proven to be defective in material or workmanship under normal use during the applicable warranty time period. Anything replaced under warranty becomes the property of American Honda Motor Co., Inc. The warranty on all parts, accessories, and apparel replaced under warranty will expire coincident with the original warranty on the replaced parts, accessories, or apparel.

Parts and accessories installed by a dealer who is authorized by American Honda to sell them will be repaired or replaced under warranty without charge for parts or labor. If installed by anyone else, parts and accessories will be repaired or replaced under warranty without charge for parts, but any labor charges will be the responsibility of the purchaser.

Apparel will be repaired or replaced under warranty without any charge.

To Obtain Warranty Service:

You must, at your expense, take the Honda Power Equipment part, accessory, apparel or the Honda Power Equipment on which the part or accessory is installed, and proof of purchase to any Honda Power Equipment dealer in the United States, Puerto Rico, or the U.S. Virgin Islands who is authorized to sell that product, during the dealer's normal business hours. To locate a dealer near you, visit our web site at PowerEquipment.Honda.com and click on Find a Dealer.

If you are unable to obtain warranty service or are dissatisfied with the warranty service you receive, contact the owner of the dealership involved; normally this will resolve the problem. However, if you should require further assistance, write or call the Power Equipment Customer Relations Department of American Honda Motor Co., Inc. See "How to Contact Honda" on [page 19](#).

Exclusions:

This warranty does not extend to parts, accessories, or apparel affected or damaged by collision, normal wear, use in an application for which the product was not designed or any other misuse, neglect, incorporation or use of unsuitable attachments or parts, unauthorized alteration, improper installation, or any causes other than defects in material or workmanship of the product. Installing parts and accessories on non-Honda products or engines voids this warranty.

Disclaimer of Consequential Damage and Limitation of Implied Warranties:

American Honda disclaims any responsibility for loss of time or use of the product, or the power equipment on which the product is installed, transportation, commercial loss, or any other incidental or consequential damage. Any implied warranties are limited to the duration of this written warranty. Some states do not allow limitations on how long an implied warranty lasts and/or do not allow the exclusion or limitation of incidental or consequential damages, therefore the above exclusions and limitations may not apply to you.

This warranty gives you specific legal rights, and you may also have other rights which vary from state to state.

PWL50623-X

EMISSION SYSTEM WARRANTY

Your new Honda Power Equipment engine complies with the U.S. EPA, Environment Canada, and State of California (models certified for sale in California only) emission regulations. American Honda Motor Co., Inc. provides the emission warranty coverage for engines in the United States and its territories. Honda Canada Inc. provides the emission warranty for engines in the 13 provinces and territories of Canada. In the remainder of this Emission Control System Warranty, American Honda Motor Co., Inc. and Honda Canada Inc. will be referred to as Honda.

CALIFORNIA EXHAUST AND EVAPORATIVE EMISSIONS CONTROL WARRANTY STATEMENT YOUR WARRANTY RIGHTS AND OBLIGATIONS

The California Air Resources Board and Honda are pleased to explain the exhaust and evaporative emissions ("emissions") control system warranty on your 2020 and later Honda Power Equipment engine. In California, new equipment that use small off-road engines must be designed, built, and equipped to meet the State's stringent anti-smog standards. Honda must warrant the emissions control system on your power equipment engine for the periods of time listed below provided there has been no abuse, neglect, or improper maintenance of your small off-road engine or equipment leading to the failure of the emissions control system.

Your emissions control system may include parts such as the carburetor or fuel-injection system, the ignition system, catalytic converter, fuel tanks, fuel lines (for liquid fuel and fuel vapors), fuel caps, valves, canisters, filters, clamps and other associated components. Also included may be hoses, belts, connectors, and other emission-related assemblies (see the adjacent column for additional covered parts).

Where a warrantable condition exists, Honda will repair your power equipment engine at no cost to you including diagnosis, parts and labor.

MANUFACTURER'S WARRANTY COVERAGE:

The exhaust and evaporative emissions control system on your Honda power equipment engine is warranted for two years. If any emissions-related part on your Honda power equipment engine is defective, the part will be repaired or replaced by Honda.

OWNER'S WARRANTY RESPONSIBILITY:

- As the power equipment engine owner, you are responsible for the performance of the required maintenance listed in your owner's manual. Honda recommends that you retain all receipts covering maintenance on your power equipment engine, but Honda cannot deny warranty coverage solely for the lack of receipts or for your failure to ensure the performance of all scheduled maintenance.
- As the power equipment engine owner, you should however be aware that Honda may deny you warranty coverage if your power equipment engine or a part has failed due to abuse, neglect, improper maintenance, or unapproved modifications.
- You are responsible for presenting your power equipment engine to a Honda Power Equipment servicing dealer as soon as the problem exists. The warranty repairs shall be completed in a reasonable amount of time, not to exceed 30 days.

If you have any questions regarding your warranty rights and responsibilities, you should contact the Honda office in your region:

American Honda Motor Co., Inc.
Power Equipment
Customer Relations
4900 Marconi Drive
Alpharetta, Georgia 30005-8847
Telephone: (888) 888-3139
Email: powerequipmentemissions@ahm.honda.com

Honda Canada Inc.
Power Equipment
Customer Relations
180 Honda Blvd.
Markham, ON, L6C 0H9
Telephone: (888) 946-6329

or

YOUR WARRANTY RIGHTS AND OBLIGATIONS

Other States, U.S. territories, and Canada:

In other areas of the United States and in Canada, your engine must be designed, built, and equipped to meet the U.S. EPA and Environment Canada emission standards for spark-ignited engines at or below 19 kilowatts.

Specific Honda products that do not meet the California emissions regulations can be identified by a "California: Not for sale or use" or "California: Only for use in Farming or Construction Equipment" decal.

All of the United States and Canada:

The exhaust and evaporative emissions control system on your Honda power equipment engine sold in the United States and Canada is warranted for two years from the date of delivery to the ultimate purchaser or the length of the Honda Distributor's Limited Warranty, whichever is longer. This warranty is transferable to each subsequent purchaser for the duration of the warranty period.

If any emissions-related part on your Honda power equipment engine is defective, the part will be repaired or replaced by Honda. All defective parts

replaced under this warranty become the property of Honda. Only Honda approved replacement parts may be used in the performance of any warranty repairs and must be provided without charge to the owner. A list of warranted parts is shown in the table below. All emission related parts are under warranty for the remainder of the warranty period. Normal maintenance items, such as spark plugs and filters, that are on the warranted parts list are warranted up to their required replacement interval only.

Honda will also replace other engine components damaged by a failure of any warranted part during the warranty period. Honda cannot deny coverage under the emission warranty solely for use of non-Honda replacement parts or service performed at a location other than an authorized Honda dealership; however, use of a part that is not functionally identical to the original equipment part in any respect that may in any way affect emissions (including durability) could result in denial of coverage. If such a non-Honda replacement part is used in the repair or maintenance of your engine, and an authorized Honda dealer determines it is defective or causes a failure of a warranted part, your claim for repair of your engine may be denied. If the part in question is not related to the reason your engine requires repair, your claim will not be denied.

TO OBTAIN WARRANTY SERVICE:

You must, at your own expense, take your Honda Power Equipment engine or the product on which it is installed, along with your sales registration card or other proof of original purchase date, to any Honda Power Equipment dealer who is authorized by Honda to sell and service that Honda product during their normal business hours. Claims for repair or adjustment found to be caused solely by defects in material or workmanship will not be denied because the engine was not properly maintained and used.

If you are unable to obtain emission warranty service or are dissatisfied with the warranty service you received, contact the owner of the dealership involved. Normally this should resolve your problem. However, if you require further assistance, contact the Honda office in your region using the information shown in the adjacent column.

EXCLUSIONS:

Failures other than those resulting from defects in material or workmanship are not covered by this warranty. This warranty does not extend to emission control systems or parts that are affected or damaged by owner abuse, neglect, improper maintenance, or unapproved modifications.

This warranty does not cover replacement of expendable maintenance items made in connection with required maintenance service after the item's first scheduled replacement as listed in the maintenance section of the product owner's manual, such as: spark plugs and filters.

DISCLAIMER OF CONSEQUENTIAL DAMAGE AND LIMITATION OF IMPLIED WARRANTIES:

American Honda Motor Co., Inc. and Honda Canada Inc. disclaim any responsibility for incidental or consequential damages such as loss of time or the use of the power equipment, or any commercial loss due to the failure of the equipment; and any implied warranties are limited to the duration of this written warranty. This warranty is applicable only where the California, U.S. EPA, or Environment Canada emission control system warranty regulation is in effect.

EMISSION CONTROL SYSTEM WARRANTY PARTS:

SYSTEMS COVERED BY THIS WARRANTY:	PARTS DESCRIPTION:
Fuel Metering	Carburetor assembly (includes starting enrichment system), Oxygen sensor, Throttle body, Engine temperature sensor, Engine control module, Fuel injector, Fuel regulator, Intake manifold
Evaporative	Fuel tank, Fuel cap, Fuel lines (for liquid and fuel vapors), Carbon canister, Canister mounting brackets, Fuel line fittings, Fuel strainer, Fuel valve, Fuel pump, Fuel hose joint, Canister purge port connector
Exhaust	Catalyst, Exhaust pipe, Muffler (with catalyst), Exhaust manifold
Air Induction	Air cleaner case, Air cleaner element*
Ignition	Flywheel comp., Flywheel magneto, Ignition pulse generator, Crankshaft position sensor, Power coil, Ignition coil assembly, Ignition control module, Spark plug cap, Spark plug*
Crankcase Emission Control	Crankcase breather tube, Breather valve assembly, Oil filler cap
Miscellaneous Parts	Tubing, fittings, seals, gaskets, and clamps associated with these listed systems.

* Covered up to the first required replacement only. See the Maintenance Schedule on [page 10](#). PWL50975-U

NOTES

PRODUCT REGISTRATION

Thank you for choosing Honda!
Please register your generator within 30 days of purchase to ensure you receive important service information in the event of a product update or recall and for added coverage during certain sales promotions.

Your information will remain confidential.
It will not be released to any other company or organization.

There are three ways to register, select one:

- Complete and mail the postage paid card shown below
- Complete and submit the online form at powerequipment.honda.com
- Scan the QR code and then complete and submit the online form



EABA
#####

Print your 7-digit serial number here.

Serial number		* Dealer Store number	* Dealer ZIP code
E	A	B	A
____		_____	_____
Owner's Last Name		First Name	
_____		_____	
Company Name <i>(commercial/rental users)</i>		Telephone	
_____		(____) _____	
Address			

City		State	ZIP Code
_____		_____	_____
E-mail address			

Date of Purchase		Purchased Via <i>(check one)</i>	
____	____	<input type="checkbox"/> In Store	<input type="checkbox"/> Online
MONTH	DAY	YEAR	
Application <i>(check one)</i>		<input type="checkbox"/> Commercial <i>(professional use)</i>	<input type="checkbox"/> Non-commercial <i>(private, homeowner use)</i>
		<input type="checkbox"/> Rental <i>(for-hire use)</i>	

1. Go to: powerequipment.honda.com to register your unit.

HONDA GENERATORS LAWN MOWERS ROBOTIC MOWERS PUMPS SNOW BLOWERS TILLERS TRIMMERS SUPPORT

The All-New Honda Open Frame Inverter Generators

Power You Can Trust.

Product Registration

Congratulations on the purchase of your new Honda Product! Thank you for registering online. Your information will remain confidential. It will not be released to any other company or organization. Please enter your serial number to get started.

Serial Number (i.e. MAGA-1234567)*
Need help finding your serial number?

Title First Name* MI Last Name* Suffix Address Line 1* Address Line 2 City* State* Zip Code* Email* Confirm Email* Phone (Numbers only, no dashes or parentheses)* Date Purchased* Product Use* Location Purchased Purchased Via* **Submit ▶**

Generators **Lawn Mowers** **Pumps** **Snow Blowers** **Tillers** **Trimme**

Generators Home back up Recreation Industrial Accessories
Lawn Mowers Residential Commercial Accessories
Robotic Mowers Mlmo Explore Mlmo Mlmo Installation About Mlmo Support
Pumps DeWatering Trash Chemical - Ag Submersible Diaphragm Accessories
Snow Blowers Single stage Two stage Accessories
Tillers Mini-tiller Mid-tine Rear-tine Accessories
Trimmers Trimmers Brushcutters Accessories
Service and Support Owners Manuals Shop Manuals Parts Information Warranty Information Support Videos Product Registration
Additional Resources Financing Special Offers Honda Heroes About Us Brochures News Shows and Events Non U.S. Customers Become a Dealer Honda Power Products Hist Site Map Email Sign Up

2. Click on Product Registration.

3. Complete the required information and click Submit.

It's that simple!

Product Registration



NO POSTAGE
NECESSARY
IF MAILED
IN THE
UNITED STATES

BUSINESS REPLY MAIL

FIRST-CLASS MAIL PERMIT NO. 117 ALPHARETTA GA

POSTAGE WILL BE PAID BY ADDRESSEE

Power Equipment Division
American Honda Motor Co., Inc.
4900 Marconi Dr
Alpharetta GA 30005-9956

EM5 K0

HP.E.2020.01
PRINTED IN U.S.A.

