

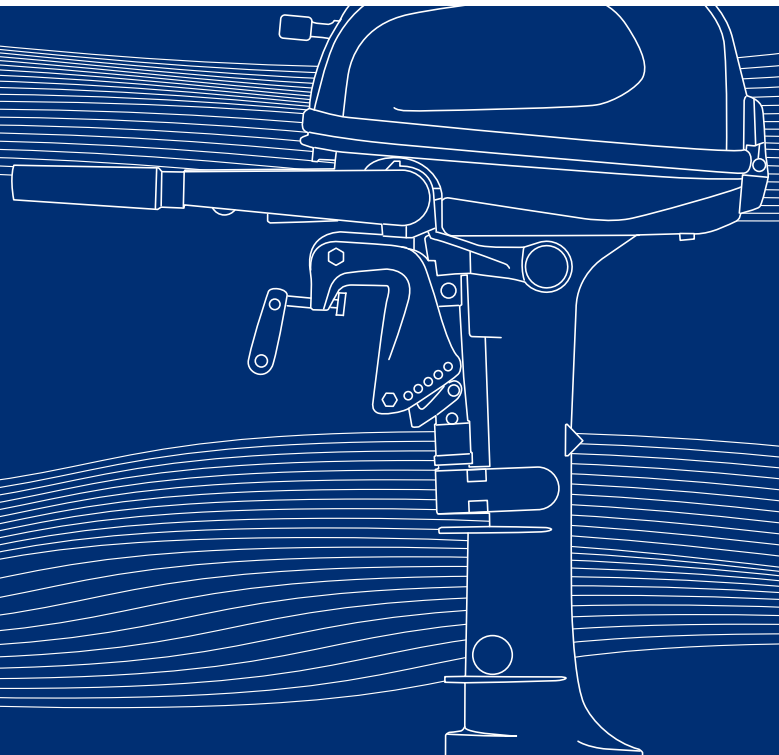

Owner's Manual  
BF4A • BF5D • BF6A

Includes US and Canadian Models

© 2021 Honda Motor Co., Ltd. - All Rights Reserved



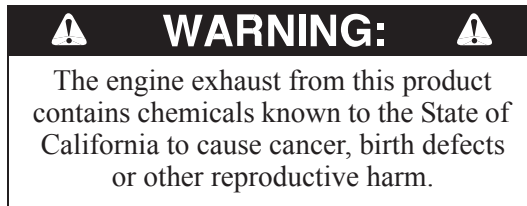

Keep this Owner's Manual handy, so you can refer to it at any time. This Owner's Manual is considered a permanent part of the outboard motor and should remain with the outboard motor if resold.

The information and specifications included in this publication were in effect at the time of approval for printing. Honda Motor Co., Ltd. reserves the right, however, to discontinue or change specifications or design at any time without notice and without incurring any obligation whatsoever. No part of this publication may be reproduced without written permission.

# INTRODUCTION

Congratulations on your selection of a Honda outboard motor. We are certain you will be pleased with your purchase of one of the finest outboard motors on the market.

We want to help you get the best results from your new outboard motor and to operate it safely. This manual contains information on how to do that; please read it carefully.

As you read this manual you will find information preceded by a

**NOTICE** symbol. That information is intended to help you avoid damage to your outboard motor, other property, or the environment.

We suggest you read the warranty policy to fully understand its coverage and your responsibilities of ownership (see page 112).

When your outboard motor needs scheduled maintenance, keep in mind that your Honda Marine dealer is specially trained in servicing Honda outboard motors. Your Honda Marine dealer is dedicated to your satisfaction and will be pleased to answer your questions and concerns.

# INTRODUCTION

---

## A FEW WORDS ABOUT SAFETY

Your safety and the safety of others are very important. And using this outboard motor safely is an important responsibility.

To help you make informed decisions about safety, we have provided operating procedures and other information on labels and in this manual. This information alerts you to potential hazards that could hurt you or others.

Of course, it is not practical or possible to warn you about all the hazards associated with operating or maintaining an outboard motor. You must use your own good judgment.

You will find important safety information in a variety of forms, including:

- **Safety Labels** – on the outboard motor.
- **Safety Messages** – preceded by a safety alert symbol  and one of three signal words, DANGER, WARNING, or CAUTION.

These signal words mean:

 **DANGER**

You **WILL** be **KILLED** or **SERIOUSLY HURT** if you don't follow instructions.

 **WARNING**

You **CAN** be **KILLED** or **SERIOUSLY HURT** if you don't follow instructions.

 **CAUTION**

You **CAN** be **HURT** if you don't follow instructions.

- **Safety Headings** – such as *IMPORTANT SAFETY INFORMATION*.
- **Safety Section** – such as *OUTBOARD MOTOR SAFETY*.
- **Instructions** – how to use this outboard motor correctly and safely.

This entire book is filled with important safety information – please read it carefully.



# CONTENTS

OUTBOARD MOTOR SAFETY .....	6	INDICATORS .....	24
IMPORTANT SAFETY INFORMATION .....	6	Oil Pressure Indicator .....	24
SAFETY LABEL LOCATIONS .....	8	Cooling System Indicator .....	25
CONTROLS AND FEATURES .....	14	OTHER FEATURES .....	25
CONTROL AND FEATURE		Rev Limiter .....	25
IDENTIFICATION CODES .....	14	Anode .....	25
COMPONENT AND CONTROL LOCATIONS ...	15	Fuel Hose Connector Cap and Fuel Hose	
CONTROLS .....	17	Connector .....	26
Emergency Stop Switch Clip and Emergency		Portable Fuel Tank .....	26
Stop Switch .....	17	Fuel Filler Cap Vent Knob .....	26
Choke Knob .....	17	Fuel Priming Bulb .....	27
Throttle Grip .....	18	Battery Charge Cable .....	27
Throttle Friction Knob .....	18	INSTALLATION .....	30
Gearshift Lever .....	19	POWER REQUIREMENTS .....	30
Fuel Valve Lever .....	19	INSTALLATION POSITION .....	30
Fuel Filler Cap Vent Knob .....	21	ATTACHMENT .....	31
Starter Grip .....	22	TRANSOM ANGLE ADJUSTMENT .....	31
Engine Cover Latch .....	22	BATTERY CONNECTIONS .....	32
Transom Angle Adjusting Rod .....	22	Battery .....	32
Steering Friction Bolt .....	23	Battery Terminals .....	33
Tilt Lever .....	23	BEFORE OPERATION .....	34
Handle Stopper .....	23	ARE YOU READY TO GET UNDERWAY? .....	34
		IS YOUR OUTBOARD MOTOR	
		READY TO GO? .....	34

# CONTENTS

---

OPERATION .....	36	TOOL KIT AND EMERGENCY STARTER	
SAFE OPERATING PRECAUTIONS .....	36	ROPE .....	60
BREAK-IN PROCEDURE .....	36	MAINTENANCE SCHEDULE .....	61
TRANSOM ANGLE ADJUSTMENT .....	37	ENGINE COVER REMOVAL AND	
PRIMING THE CARBURETOR WITH		INSTALLATION .....	63
GASOLINE .....	37	Engine Oil Level Check .....	64
PORTABLE FUEL TANK .....	39	Engine Oil Change .....	65
FUEL HOSE CONNECTIONS .....	40	Engine Oil Recommendations .....	67
FUEL PRIMING .....	40	Gear Case Oil Change .....	67
INFREQUENT OR OCCASIONAL USE .....	41	Lubrication Points .....	69
STARTING THE ENGINE .....	41	Spark Plug Service .....	70
EMERGENCY STARTING .....	45	REFUELING .....	71
STOPPING THE ENGINE .....	51	FUEL RECOMMENDATIONS .....	74
Emergency Engine Stopping .....	51	Fuel Filter Inspection and Replacement .....	75
Normal Engine Stopping .....	51	Portable Fuel Tank and Tank Filter Cleaning .....	77
GEARSHIFTING AND THROTTLE		Recoil Starter Rope Inspection .....	78
OPERATION .....	53	Anode Replacement .....	78
STEERING .....	54	Propeller and Shear Pin Replacement .....	79
CRUISING .....	55		
SHALLOW WATER OPERATION .....	56		
MOORING, BEACHING, LAUNCHING .....	57		
SERVICING YOUR OUTBOARD MOTOR .....	58		
THE IMPORTANCE OF MAINTENANCE .....	58		
MAINTENANCE SAFETY .....	59		

# CONTENTS

CLEANING AND FLUSHING .....	81	OIL PRESSURE INDICATOR GOES OFF AND ENGINE SPEED IS LIMITED .....	97
Cleaning and Flushing .....	81	SUBMERGED OUTBOARD MOTOR .....	98
STORAGE .....	84	TECHNICAL INFORMATION .....	100
Fuel .....	84	Serial Number Locations .....	100
Engine Oil .....	86	Carburetor Modification for High Altitude Operation .....	101
Engine Cylinder .....	86	Battery .....	101
STORAGE PRECAUTIONS .....	87	Emission Control System Information .....	102
REMOVAL FROM STORAGE .....	88	Star Label .....	104
TRANSPORTING .....	89	Specifications .....	106
WITH OUTBOARD MOTOR INSTALLED ON BOAT .....	89	Specifications .....	107
WITH OUTBOARD MOTOR REMOVED FROM BOAT .....	90	Specifications .....	108
TAKING CARE OF UNEXPECTED PROBLEMS .....	91	CONSUMER INFORMATION .....	109
ENGINE WILL NOT START .....	91	Dealer Locator Information .....	109
HARD STARTING OR STALLS AFTER STARTING .....	93	Honda Publications .....	109
ENGINE OVERHEATS .....	94	Customer Service Information .....	110
ENGINE WILL NOT DRIVE THE PROPELLER .....	95	Warranty Statements .....	112
BATTERY WILL NOT CHARGE (Equipped type) .....	96	Distributor's Limited Warranty .....	112
Fuse Replacement .....	96	Emission Control System Warranty .....	117
		Distributor's Warranty .....	122
		INDEX .....	125

# OUTBOARD MOTOR SAFETY

## IMPORTANT SAFETY INFORMATION

The Honda BF4A, BF5D and BF6A outboard motors are designed for use with boats that have a suitable manufacturer's power recommendation. Other uses can result in injury to the operator or damage to the outboard motor and other property.

Most injuries or property damage can be prevented if you follow all instructions in this manual and on the outboard motor. The most common hazards are discussed in this chapter, along with the best way to protect yourself and others.

## Operator Responsibility

- It is the operator's responsibility to provide the necessary safeguards to protect people and property. Know how to stop the engine quickly in case of emergency. Understand the use of all controls.
  - Stop the engine immediately if anyone falls overboard, and do not run the engine while the boat is near anyone in the water.
  - Always stop the engine if you must leave the controls for any reason.
- Attach the emergency stop switch lanyard securely to the operator.
  - Always wear a PFD (Personal Flotation Device) while on the boat.
  - Familiarize yourself with all laws and regulations relating to boating and the use of outboard motors.
  - Be sure that anyone who operates the outboard motor receives proper instruction.
  - Be sure the outboard motor is properly mounted on the boat.
  - Do not remove the engine cover while the engine is running.

## Refuel With Care

- Gasoline is extremely flammable, and gasoline vapor can explode. Refuel outdoors, in a well-ventilated area, with the engine stopped. Never smoke near gasoline, and keep other flames and sparks away.
- Remove any portable fuel tank from the boat for refueling. Keep the portable fuel tank away from the battery or other potential spark sources.
- Refuel carefully to avoid spilling fuel. Avoid overfilling the fuel tank.
- After refueling, tighten the filler cap securely. If any fuel is spilled, make sure the area is dry before starting the engine.

## Carbon Monoxide Hazard

Exhaust contains poisonous carbon monoxide, a colorless, odorless gas. Breathing carbon monoxide can cause loss of consciousness and may lead to death.

If you run the engine in an area that is confined, or even partly enclosed, the air you breathe could contain a dangerous amount of exhaust gas.

Never run your outboard inside a garage or other enclosure.

## WARNING

Running the engine of your outboard while in an enclosed or partially enclosed area can cause a rapid build-up of toxic carbon monoxide gas.

Breathing this colorless, odorless gas can quickly cause unconsciousness and lead to death.

Only run your outboard engine when it is located in a well ventilated area outdoors.

# OUTBOARD MOTOR SAFETY

## SAFETY LABEL LOCATIONS

### US, Puerto Rico, and US Virgin Islands Types

 **Read owner's manual carefully before operation.**

**WARNING**

 **Keep away from flames.**  
**Stop the engine before refueling.**  
**Wipe off spilled gasoline before starting.**  
**When carrying, shut breather valve and fuel valve.**

**Place transmission in neutral before starting.**  
**Do not operate with engine cover removed.**  
**Be sure the antivibration plate is below the water line.**  
**Do not shift to reverse suddenly at high speed.**

**Gasoline only.**  
**Check oil level before starting.**  
**Flush the system thoroughly with fresh water after each use in salt water.**  
**Emergency starting instructions are on top of engine.**

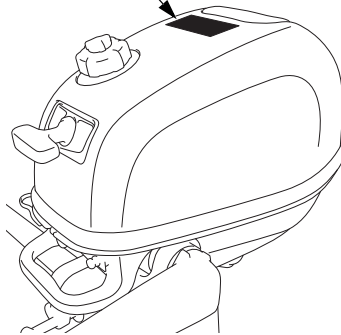

# OUTBOARD MOTOR SAFETY

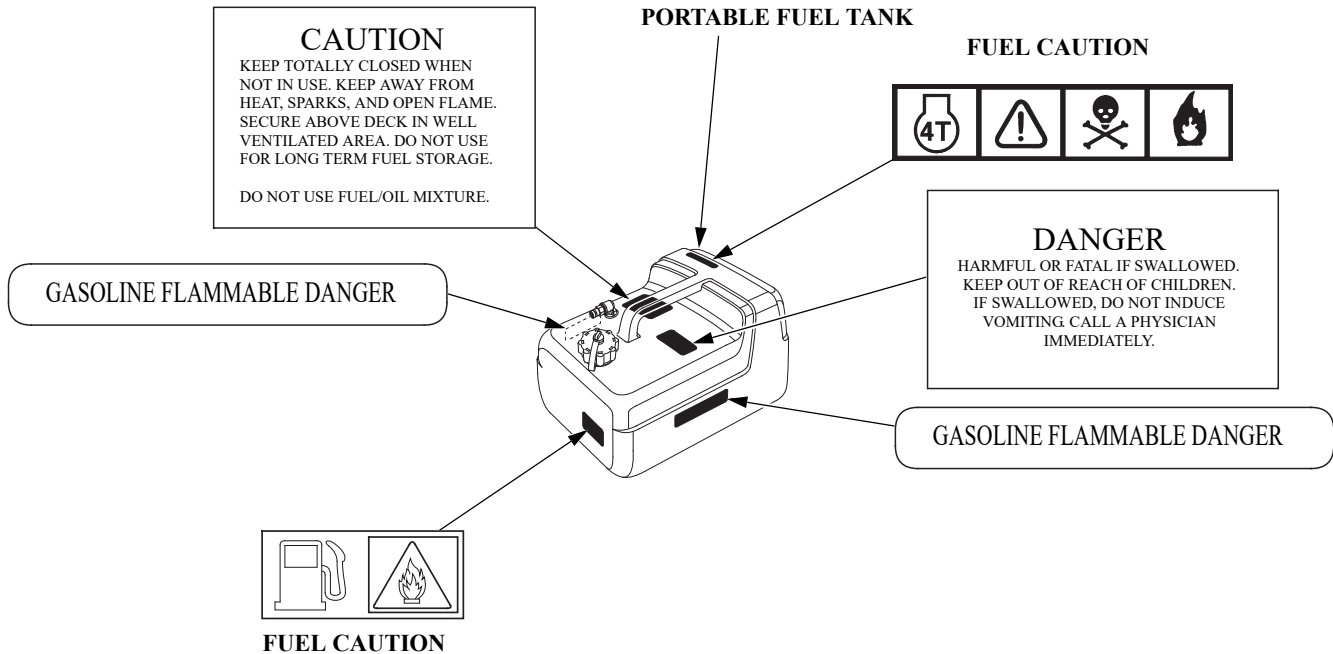

The labels shown here contain important safety information. Please read them carefully. These labels are considered permanent parts of your outboard motor. If a label comes off or becomes hard to read, contact an authorized Marine dealer for a replacement.

# OUTBOARD MOTOR SAFETY

## Canadian Types

Ⓢ DO NOT SHIFT TO REVERSE SUDDENLY AT HIGH SPEED.  
 Ⓢ BEI HOHER FAHRGESCHWINDIGKEIT AUF KEINEN FALL PLÖTZLICH DEN RÜCKWÄRTSGANG EINLEGEN.  
 Ⓢ NE PAS ENGAGER LA MARCHÉ ARRIÈRE BRUSQUEMENT A GRANDE VITESSE.  
 Ⓢ BIJ HOGE SNELHEID NIET PLOTSELING IN DE ACHTERUIT-VERSNELLING SCHAKELEN.  
 Ⓢ NON INGRANATE IMPROVVISAMENTE LA RETROMARCIA AD ALTA VELOCITÀ.  
 Ⓢ NO PONER LA MARCHA ATRÁS DE REPENTE CUANDO CIRULE A ALTA VELOCIDAD.  
 Ⓢ NÃO MUDE REPENTINAMENTE PARA MARCHA ATRÁS A ALTA VELOCIDADE.  
 Ⓢ ALÄ VÄHDA ÄRLLIBESTI PERUUTUSVAIHEELLE NOPEASSA VAURDISSA.  
 Ⓢ GIRET MÅ IKKE SETTES I REVERS NÅR DET KJØRES MED HØY HASTIGHET.  
 Ⓢ LÄGG INTE PLOTSLICKT IN I BACKEN VID KÖRNING PÅ HÖG HASTIGHET.  
 Ⓢ 고속에서 갑자기 후진으로 전환하지 마십시오.

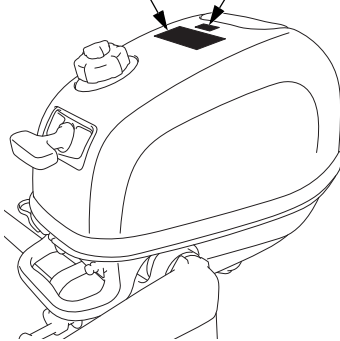

**WARNING**

Read owner's manual.

**Emergency starting**

1. Remove coil starter.
2. Put gear selector in N (Neutral).
3. Trip brake cable of engine.

Ⓢ Pull up on the engine cover while pulling rope.

Ⓢ Install engine cover after starting engine.

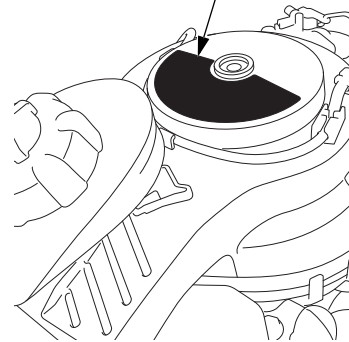



# OUTBOARD MOTOR SAFETY

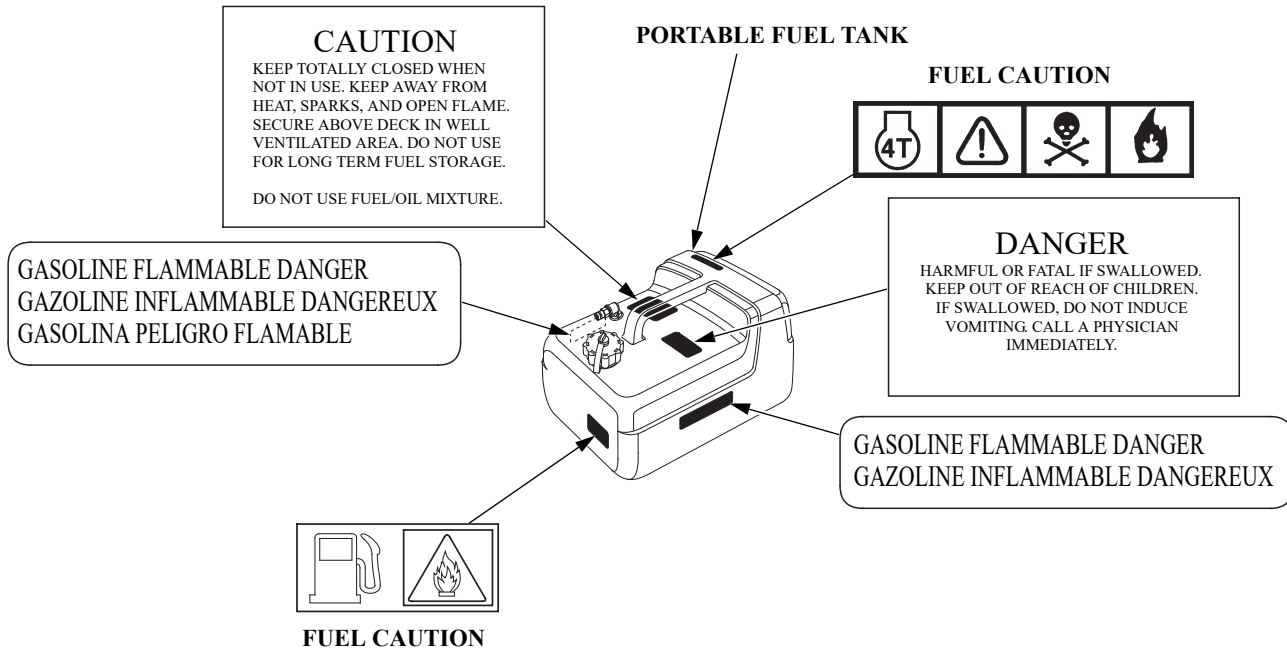

The labels shown here contain important safety information. Please read them carefully. These labels are considered permanent parts of your outboard motor. If a label comes off or becomes hard to read, contact an authorized Marine dealer for a replacement.

# OUTBOARD MOTOR SAFETY

---

## US, Puerto Rico, and US Virgin Islands Types



- Gasoline is harmful or fatal if swallowed. Keep the fuel tank out of reach of children.
- Gasoline is extremely flammable and is explosive under certain conditions. Refuel in a well-ventilated area with the engine stopped.
- Do not smoke or allow flames or sparks where the engine is refueled or where gasoline is stored.

- Do not overfill the fuel tank. After refueling make sure that the fuel filler cap is closed properly and securely.
- Be careful not to spill any fuel while refueling. Spilled fuel or fuel vapor may ignite. If any fuel is spilled, make sure that the area is dry before starting the engine.

## Canadian Types



- **Honda outboard motor is designed to give safe and dependable service if operated according to instructions. Read and understand the Owner's Manual before operating the outboard motor. Failure to do so could result in personal injury or equipment damage.**

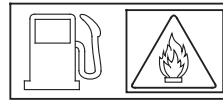

- **Gasoline is harmful or fatal if swallowed. Keep the fuel tank out of reach of children.**
- **Gasoline is extremely flammable and is explosive under certain conditions. Refuel in a well-ventilated area with the engine stopped.**
- **Do not smoke or allow flames or sparks where the engine is refueled or where gasoline is stored.**

- **Do not overfill the fuel tank. After refueling make sure that the fuel filler cap is closed properly and securely.**
- **Be careful not to spill any fuel while refueling. Spilled fuel or fuel vapor may ignite. If any fuel is spilled, make sure that the area is dry before starting the engine.**

# CONTROLS AND FEATURES

## CONTROL AND FEATURE IDENTIFICATION CODES

Model	BF4A		BF5D				BF6A			
Type	SHN□	LHN□	SHN□	SH□	LHN□	LH□	SHN□	SH□	LHN□	LH□
Shaft Length	S	•	•	•			•	•		
	L		•		•	•			•	•
Fuel Tank	Internal fuel tank	•	•	•	•	•	•	•	•	•
	Portable fuel tank			*	*	*	*	*	*	*
Charging System	*	*	*	•	*	•	*	•	*	•

Refer to this chart for an explanation of the Type Codes used in this manual to identify control and feature applications.

\*: Optional equipment

BF4A/BF5D/BF6A are provided with the following types according to the shaft length and charging system.

- Shaft Length  
S: Short Shaft  
L: Long Shaft
- Control System  
H: Tiller Handle Type
- Charging System  
N: Without System  
(Optional Equipment)

(Example)

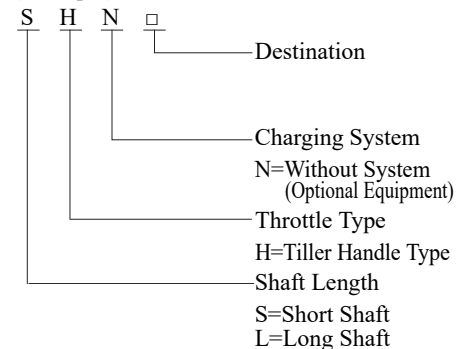

# CONTROLS AND FEATURES

## COMPONENT AND CONTROL LOCATIONS

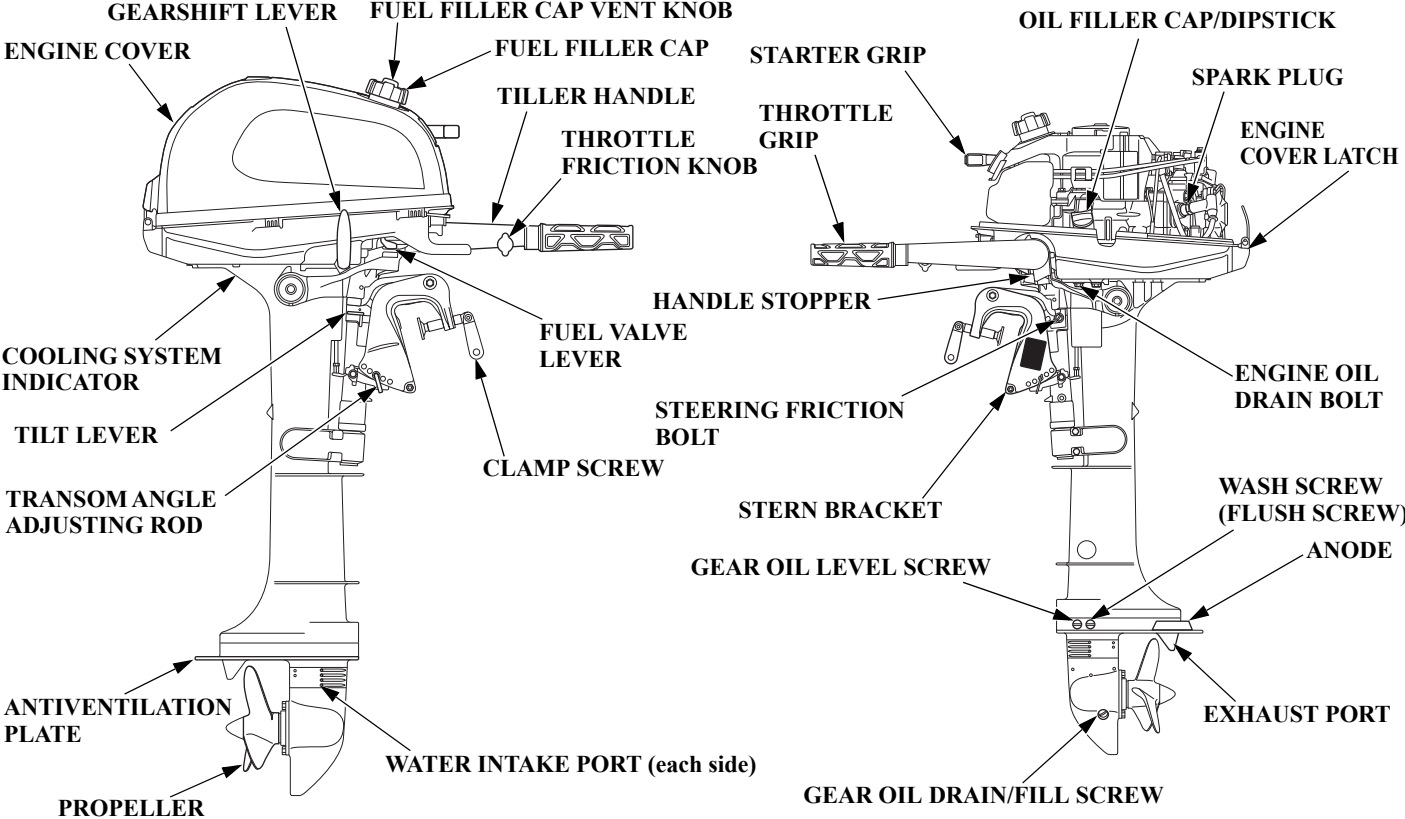

# CONTROLS AND FEATURES

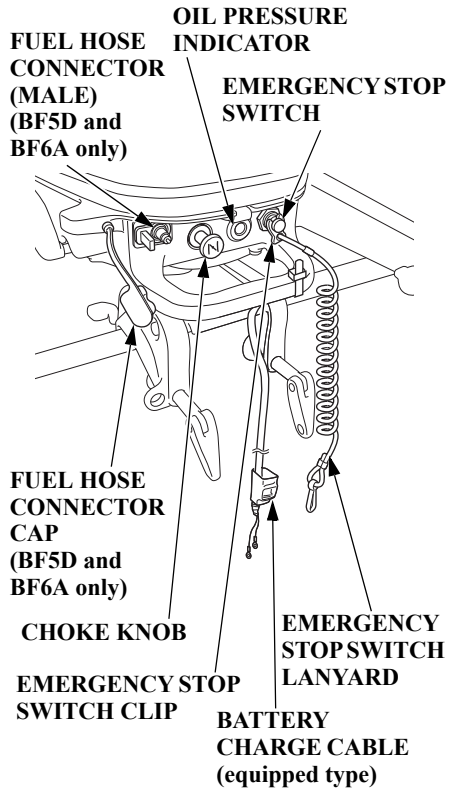

## Portable Fuel Tank (Optional Equipment for BF5D and BF6A)

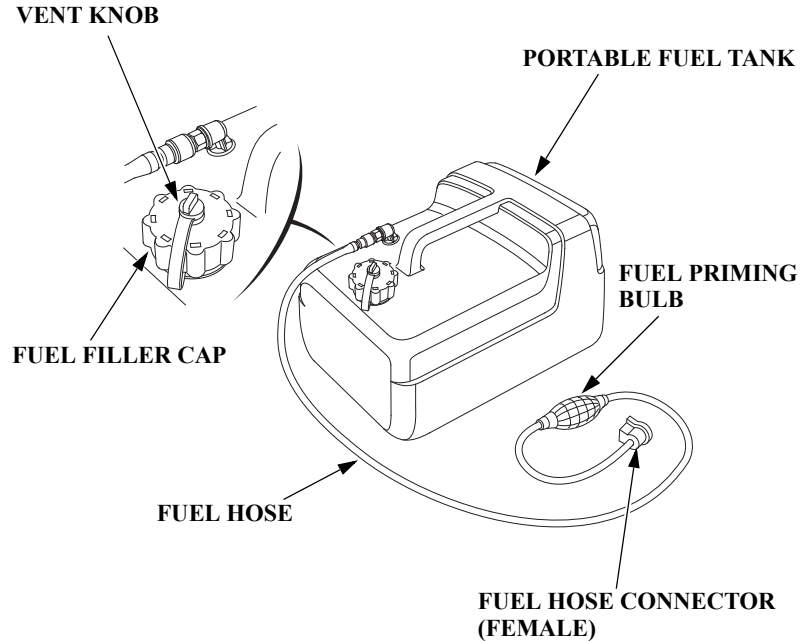

## CONTROLS

### Emergency Stop Switch Clip and Emergency Stop Switch

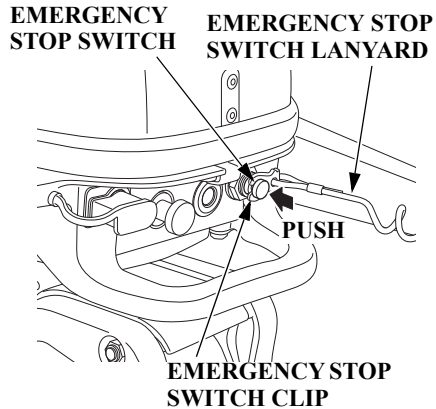

### EMERGENCY STOP SWITCH CLIP

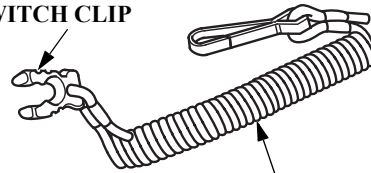

The emergency stop switch clip must be inserted in the emergency stop switch in order for the engine to start and run. The emergency stop switch lanyard must be attached securely to the operator or to the PFD (Personal Flotation Device) equipped to an operator.

When used as described, the emergency stop switch and emergency stop switch lanyard system stops the engine if the operator falls away from the controls.

A spare emergency stop switch clip is supplied with the tool kit.

## Choke Knob

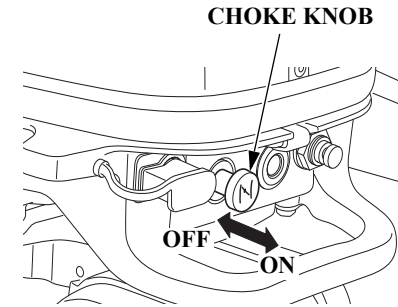

The choke knob opens and closes the choke valve in the carburetor.

The ON position enriches the fuel mixture for starting a cold engine.

The OFF position provides the correct fuel mixture for operation after starting, and for restarting a warm engine.

The choke knob is also used to restart the engine after supplying fuel when the internal fuel tank is out of fuel. For more information, refer to page 44.

# CONTROLS AND FEATURES

## Throttle Grip

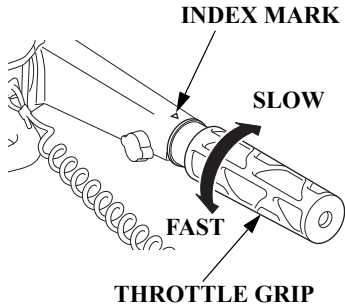

The throttle grip controls engine speed.

An index mark on the tiller handle shows throttle position and is helpful for setting the throttle correctly when starting (p. 44).

## Throttle Friction Knob

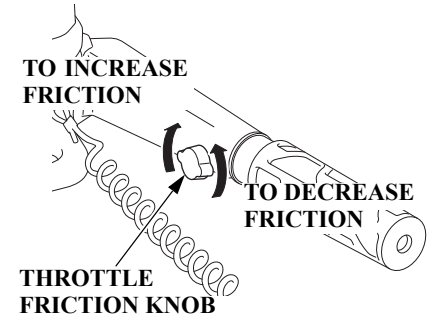

The throttle friction knob adjusts resistance to throttle grip rotation.

Turn the knob clockwise to increase friction for holding a throttle setting while cruising.

Turn the knob counterclockwise to decrease friction for easy throttle grip rotation.

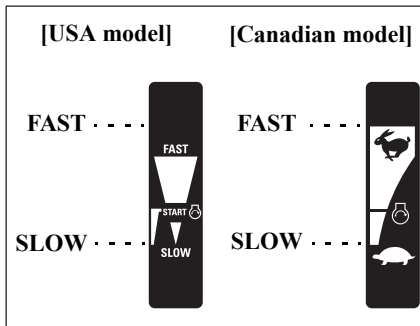



## Gearshift Lever

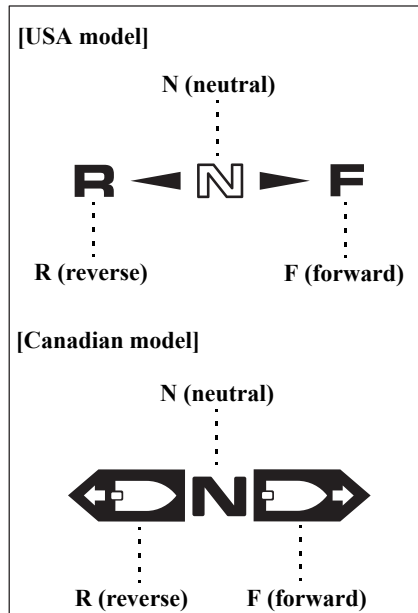
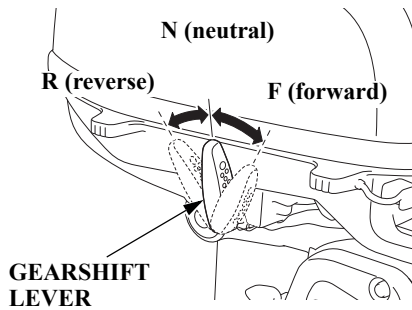

The gearshift lever is used to select F (forward), N (neutral), or R (reverse) gears.

If the gearshift lever is in the F (forward) or R (reverse) position, the recoil starter will not operate.

## Fuel Valve Lever

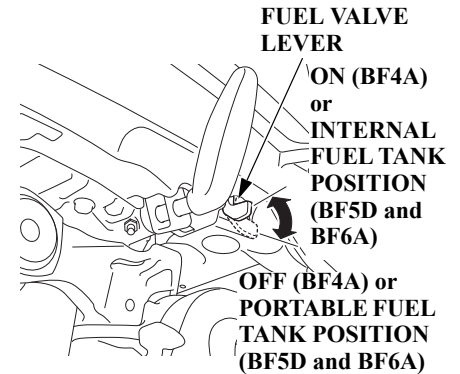

## CONTROLS AND FEATURES

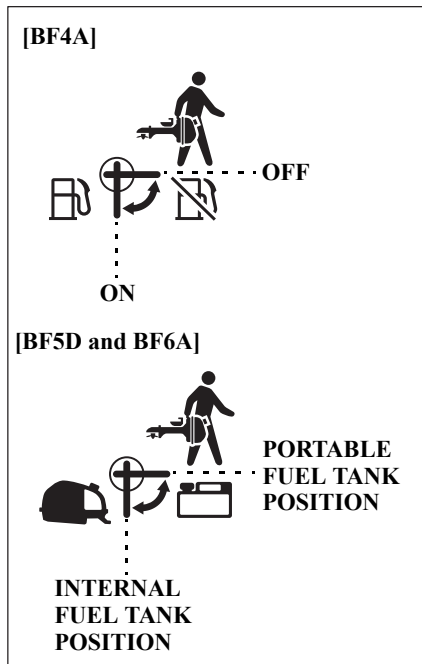

### **(BF4A)**

The fuel valve opens and closes the passage between the internal fuel tank and the carburetor.

The fuel valve lever must be in the ON position for the engine to run.

When the engine is not in use, leave the fuel valve lever in the OFF position to prevent carburetor flooding and to reduce the possibility of fuel leakage.

### **(BF5D and BF6A)**

The fuel valve lever has internal fuel tank position and portable fuel tank position.



When using the internal fuel tank, turn the fuel valve lever to the internal fuel tank position.

When not connecting the portable fuel tank, fuel is shut off at the portable fuel tank position.



When using the portable fuel tank, turn the fuel valve lever all the way to the portable fuel tank position.

## CONTROLS AND FEATURES

(BF4A)

LEVER POSITION		FUNCTION
	ON	Fuel from the internal fuel tank is supplied.
	OFF	Fuel supply is shut off. Set the fuel valve lever to the “OFF” position during transporting or storing the outboard motor.

(BF5D and BF6A)

LEVER POSITION		FUNCTION
	INTERNAL FUEL TANK	Fuel from the internal fuel tank is supplied.
	PORTABLE FUEL TANK	<ul style="list-style-type: none"> <li>Fuel from the portable fuel tank is supplied.</li> <li>If the portable fuel tank is not connected, fuel supply is shut off. Set the fuel valve lever to the “PORTABLE FUEL TANK” position during transporting or storing the outboard motor.</li> </ul>

### Fuel Filler Cap Vent Knob (Internal Fuel Tank)

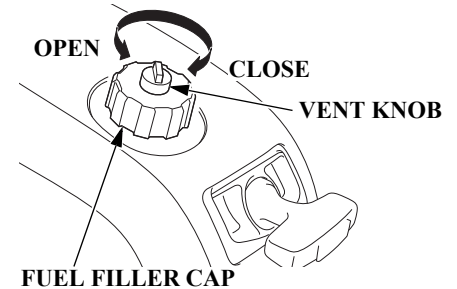

The fuel filler cap is provided with a vent knob to seal the fuel tank. Open the vent by turning the vent knob counterclockwise all the way before starting the engine. Close the vent by turning the vent knob clockwise all the way after stopping the engine.

# CONTROLS AND FEATURES

## Starter Grip

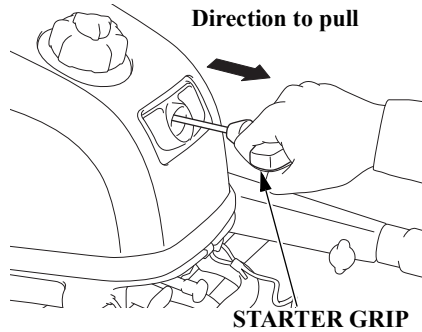

Pulling the starter grip operates the recoil starter to crank the engine for starting.

The “Neutral Starting System” prevents the starter rope from being pulled out for starting the engine unless the gearshift lever (P.19) is set in the N (neutral) position.

The engine will start only when the emergency stop switch clip is in the emergency stop switch.

## Engine Cover Latch

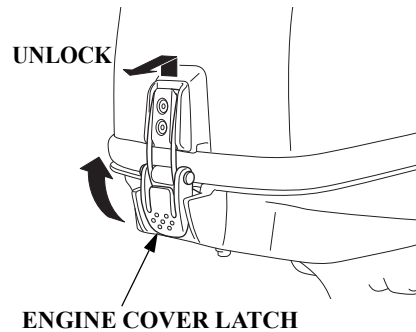

The engine cover latch fastens the engine cover to the outboard motor.

Do not remove the engine cover while the engine is running.

## Transom Angle Adjusting Rod

The transom angle adjusting rod adjusts the transom angle of the outboard motor when fully lowered.

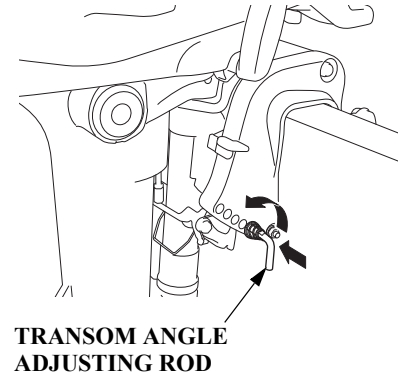

Proper adjustment prevents the outboard motor from being adjusted too low (p. 55).

## Steering Friction Bolt

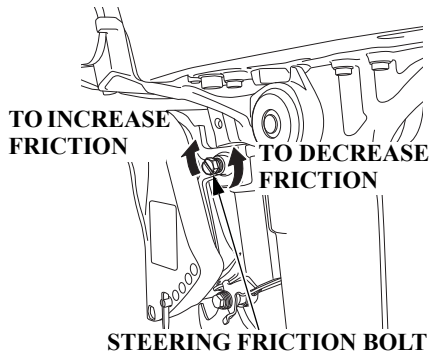

The steering friction bolt adjusts steering resistance.

Less friction allows the outboard motor to turn more easily. More friction helps to hold a steady course while cruising or to prevent the outboard motor from swinging while trailering the boat.

## Tilt Lever

ENGINE COVER GRIP

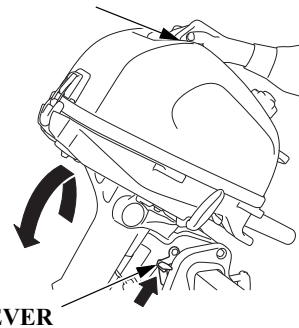

The tilt lever enables the outboard motor to be raised for shallow water operation, beaching, launching, or mooring.

To tilt, raise the outboard motor by pulling on the engine cover grip until the tilt mechanism engages at 18°, 34°, or 58° (p. 56 and 57).

## Handle Stopper

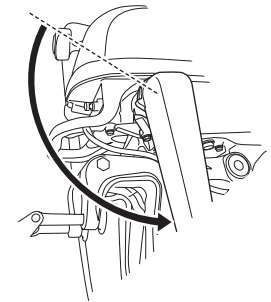
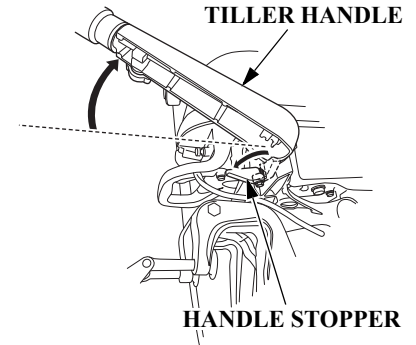

The tiller handle can be moved to the bottom direction by turning the handle stopper.

# CONTROLS AND FEATURES

---

## INDICATORS

### Oil Pressure Indicator

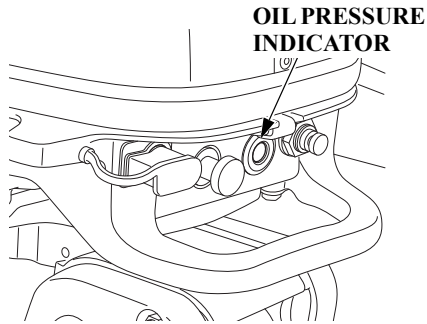

When the oil pressure indicator is lit, oil pressure is OK.

If oil pressure becomes low, the oil pressure indicator will go off, and the engine protection system will limit engine speed. Refer to *TAKING CARE OF UNEXPECTED PROBLEMS*, p. 97.

Low oil pressure indicates that the engine oil level is low or that there is a problem with the engine lubrication system.

## Cooling System Indicator

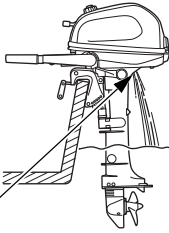

**COOLING SYSTEM  
INDICATOR**

Water should flow from the cooling system indicator while the engine is running. This shows that water is circulating through the cooling system.

If water stops flowing while the engine is running, that indicates a cooling system problem, such as clogged water intakes, which will cause engine overheating.

## OTHER FEATURES

### Rev Limiter

The engine is equipped with a rev limiter to prevent the possibility of mechanical damage from excessive engine speed.

The rev limiter may be activated during operation, limiting engine speed, if the outboard motor is tilted excessively, or when propeller ventilation occurs during a sharp turn.

If the rev limiter is activated, check the tilt angle of the outboard motor.

Improper propeller selection may also cause the rev limiter to activate.

Check to see if the correct propeller is installed.

### Anode

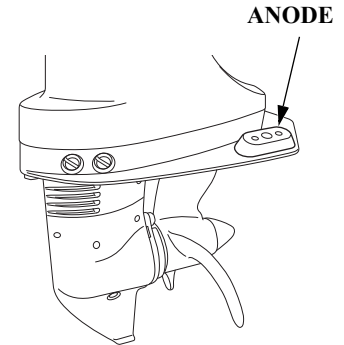

The anode is made of a sacrificial material that helps to protect the outboard motor from corrosion.

There is an anode on the antiventilation plate.

## CONTROLS AND FEATURES

### Fuel Hose Connector Cap and Fuel Hose Connector (Male) (BF5D and BF6A only)

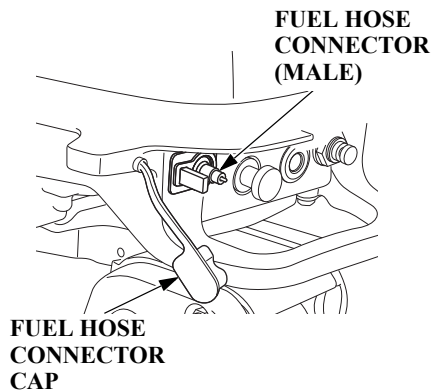

Use the fuel hose connector (male) to attach the portable fuel tank (optional equipment).

Always install the fuel hose connector cap if the fuel hose connector (female) is not connected. Be sure the fuel hose connector cap is securely installed.

### Portable Fuel Tank (Optional Equipment for BF5D and BF6A)

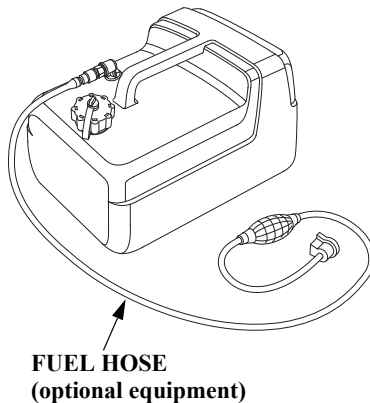

The portable fuel tank has a capacity of 3.2 US gal (12 L, 2.6 Imp gal).

### Fuel Filler Cap Vent Knob (Optional Equipment for BF5D and BF6A)

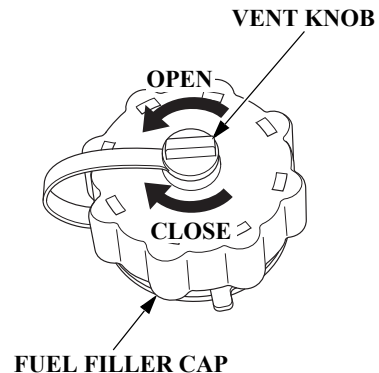

The fuel filler cap is provided with a vent knob to seal the portable fuel tank for carrying it to and from the boat. Open the vent by turning the vent knob counterclockwise all the way before starting the engine. Close the vent by turning the vent knob clockwise all the way after stopping the engine.



### Fuel Priming Bulb (Optional Equipment for BF5D and BF6A)

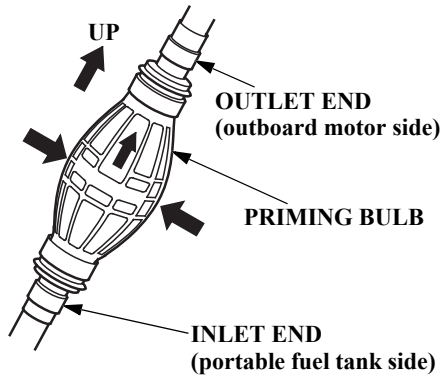

A priming bulb is built into the fuel hose that connects the portable fuel tank to the outboard motor.

Before starting the engine, hold the priming bulb up in the direction of the arrow, then squeeze the priming bulb until it feels firm. This will ensure that fuel is supplied to the engine.

### Battery Charge Cable

The battery charge cable is included in the battery charge cable kit (equipped type).

When removing the outboard motor or storing it for long periods, you can remove the battery charge cable from the outboard motor.

If the battery charge cable kit is attached, you must attach the battery. (page 32)

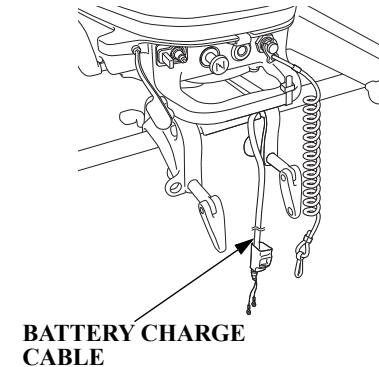

# CONTROLS AND FEATURES

## Battery Charge Cable Connection

1. Remove the covers off the charging connector and the battery charge cable connector, and save them in a secure place for later use if necessary.
2. Connect the battery charge cable connector to the charging receptacle connector.
3. Attach the wire band as shown in the figure.

### NOTICE

Starting the engine with the battery charge cable not securely connected to a battery may cause a spark if the cable terminals touch one another or a metal surface. Do not start the engine if the battery charge cable is connected to the outboard, but not connected to a battery (p. 32).

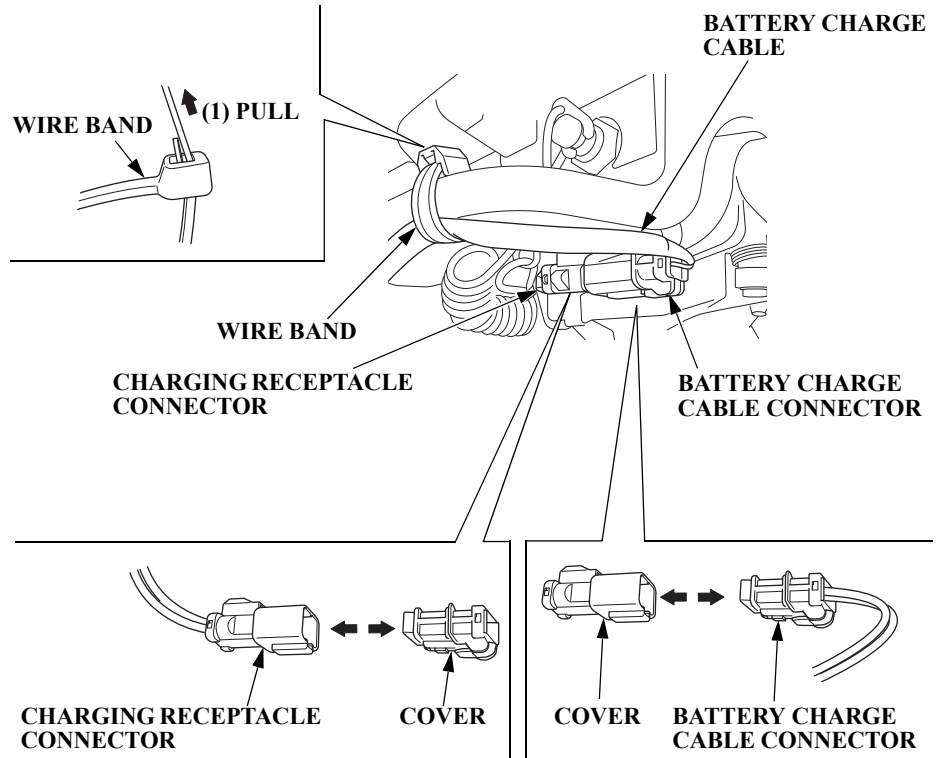

## Disconnecting Battery Charge Cable

1. Steer the tiller handle to the left with respect to the boat.

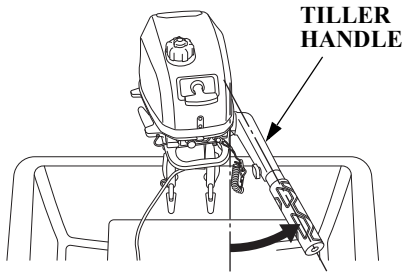

2. Remove the wire band by pulling the wire band tab in the direction shown and remove the wire band.
3. While pressing the lock on the connector, remove the battery charge cable connector from the charging receptacle connector.
4. Install the covers.

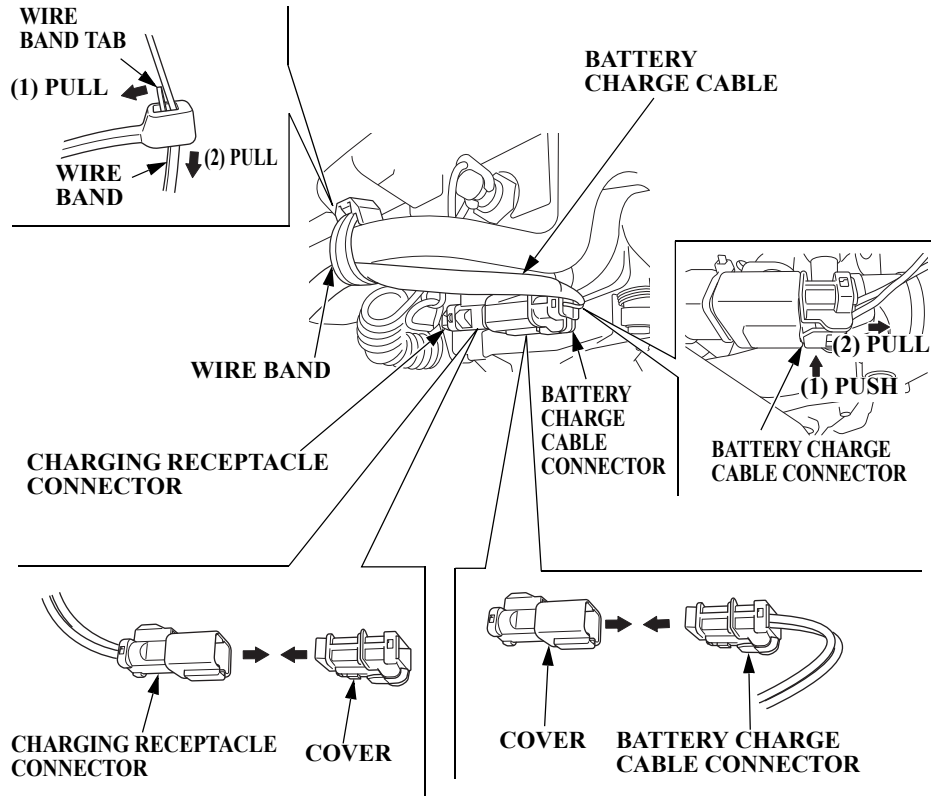

# INSTALLATION

Correct and secure installation is essential for safe boating and good performance. Follow the installation instructions provided in this manual.

## POWER REQUIREMENTS

Before installation, check to be sure that the outboard motor does not exceed the recommended maximum horsepower for the boat on which it is to be installed. Refer to the boat's certification plate for recommended maximum horsepower. If the certification plate information is not available, contact the boat dealer or manufacturer.

For most applications, the outboard motor should have a horsepower rating which provides 80% of the maximum recommended horsepower for the boat.

## INSTALLATION POSITION

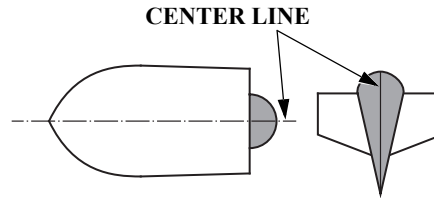

Install the outboard motor on the center of the boat transom.

The antiventilation plate of the outboard motor should be 0 – 2 in (0 – 50 mm) below the bottom of the boat.

The correct dimensions differ according to the type of boat and the configuration of the bottom of the boat. Follow the manufacturer's recommended installation height.

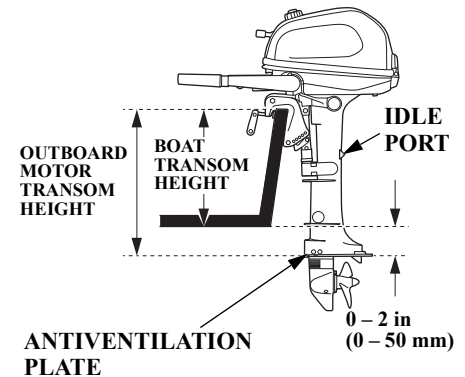

Type:	Outboard Motor Transom Height
S:	17.1 in (434 mm)
L:	22.1 in (561 mm)

When the outboard motor is installed extremely low, the idle port may be immersed and the engine may become hard to start or may run poorly. Check that the idle port is high enough from the water level when the engine is stopped with the boat fully loaded.

If the outboard motor is installed too low, the boat will squat and be hard to plane, and the outboard motor will spray water that may enter the boat. It will tend to bounce, and high-speed stability will be reduced.

If the outboard motor is installed too high, that will cause propeller ventilation.

Optimum installation height varies with boat type and bottom shape. Contact the boat manufacturer for any special recommendations that are unique to a specific model of boat.

If the transom needs to be modified to accommodate the outboard motor, contact the boat manufacturer and follow their recommendations for corrective action.

## ATTACHMENT

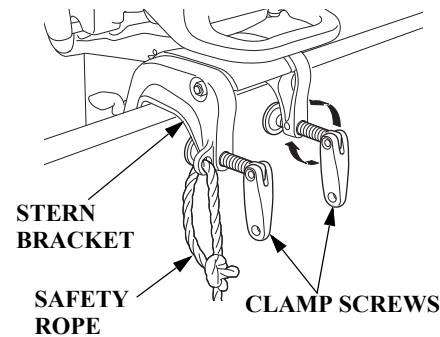

Attach the stern bracket to the boat transom by tightening the clamp screws.

Attach a rope from the boat to the hole in the stern bracket. This will help to prevent accidental loss of the outboard motor.

## TRANSOM ANGLE ADJUSTMENT

Use the transom angle adjusting rod (p. 37) to adjust the angle of the outboard motor so the propeller is perpendicular to the surface of the water.

# INSTALLATION

## BATTERY CONNECTIONS

### **⚠ WARNING**

The battery contains sulfuric acid (electrolyte), which is highly corrosive and poisonous.

Getting electrolyte in your eyes or on your skin can cause serious burns.

Wear protective clothing and eye protection when working near the battery.

**KEEP CHILDREN AWAY  
FROM THE BATTERY.**

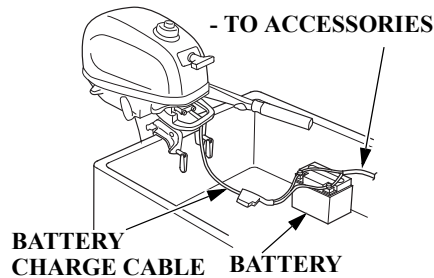

An optional accessory charging kit is available for Honda BF4A, BF5D, and BF6A outboard motors and can produce a 12-volt, 6-ampere battery charging current to charge a 12-volt battery. The battery charging circuit is protected by a 15-ampere fuse.

The outboard motor's optional accessory 12-volt charge kit is designed to charge a “starting or cranking” type battery only. It is not intended to charge a “deep-cycle” type battery. Lights and electrical accessories for the boat should be connected to the battery.

The battery should be kept in a corrosion-resistant battery box that is securely mounted in a location away from the fuel tank and protected from water and direct sunlight.

### **Battery**

For complete information, refer to the battery manufacturer's instructions.

### **Minimum Requirements**

12V-28Ah/5HR (CCA 265)

## Battery Terminals

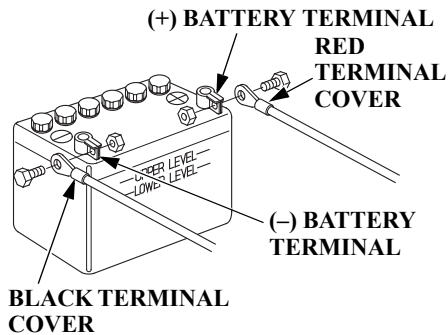

**WARNING:** Battery posts, terminals, and related accessories contain lead and lead compounds. **Wash hands after handling.**

Connect the positive (+) battery cable (red terminal cover) to the positive (+) battery terminal, then connect the negative (-) battery cable (black terminal cover) to the negative (-) battery terminal.

The negative (-) battery cable should always be removed from the battery before connecting or disconnecting the positive (+) battery cable, so tools cannot cause a short circuit if they touch a grounded part while being used on the positive (+) battery terminal fitting.

### NOTICE

- *Be careful to avoid connecting the battery in reverse polarity, as this will damage the battery-charging system in the outboard motor.*
- *Do not disconnect the battery cables while the engine is running. Disconnecting the cables while the engine is running will damage the outboard motor's electrical system.*
- *Battery cable extension: Extending the original battery cable will cause the battery voltage to drop due to the increased length of the cable and number of connections. The outboard may not start if the battery voltage reaching the engine is too low.*

# BEFORE OPERATION

## ARE YOU READY TO GET UNDERWAY?

Your safety is your responsibility. A little time spent in preparation will significantly reduce your risk of injury.

### Knowledge

Read and understand this manual. Know what the controls do and how to operate them.

Familiarize yourself with the outboard motor and its operation before you get underway. Know what to do in case of an emergency.

Familiarize yourself with all laws and regulations relating to boating and the use of outboard motors.

### Safety

Always wear a PFD (Personal Flotation Device) while on the boat.

Attach the emergency stop switch lanyard securely to the operator or to the PFD worn by the operator.

## IS YOUR OUTBOARD MOTOR READY TO GO?

For your safety, and to maximize the service life of your equipment, it is very important to take a few moments before you operate the outboard motor to check its condition. Be sure to take care of any problem you find, or have your authorized Marine dealer correct it, before you operate the outboard motor.

## WARNING

Failure to properly maintain this outboard motor, or failing to correct a problem before operation, could result in a significant malfunction.

Some malfunctions can cause serious injuries or death.

Always perform a pre-operation inspection before each operation and correct any problems.

Before beginning your pre-operation checks, be sure the emergency stop switch clip is removed from the emergency stop switch.



### Safety Inspection

- Before each use, look around and underneath the engine for signs of oil or gasoline leaks.
- If you are using the portable fuel tank, make sure it is in good condition and properly secured in the boat (p. 39).
- If you are using the portable fuel tank, check that the fuel hose is undamaged and properly connected (p. 39).
- Wipe up any spills before starting the engine.
- Check the stern bracket to be sure the outboard motor is securely installed.
- Check that all controls are operating properly.
- Replace any damaged parts.

- Check that all fasteners are in place and securely tightened.
- Check the emergency stop switch for proper operation (p. 17, 41). Start the engine (p. 41). Make sure the engine stops by pulling the emergency stop switch clip from the emergency stop switch (p. 51).

### Maintenance Inspection

- Check the engine oil level (p. 64). Running the engine with a low oil level can cause engine damage.
- Check to be sure the propeller and shear pin are undamaged (p. 79).
- Check that the anode is securely attached to the antiventilation plate (p. 78) and is not excessively worn. The anode helps to protect the outboard motor from corrosion.

- Make sure the tool kit and emergency starter rope are onboard (p. 60). Replace any missing items.
- Check the fuel level in the fuel tank (p. 71).
- If you are using the battery, check that the battery fluid is between the upper and lower levels, and the battery leads are connected securely.

# OPERATION

## SAFE OPERATING PRECAUTIONS

To safely realize the full potential of this outboard motor, you need a complete understanding of its operation and a certain amount of practice with its controls.

Before operating the outboard motor for the first time, please review the *IMPORTANT SAFETY INFORMATION* on page 6 and the chapter titled *BEFORE OPERATION*.

For your safety, do not start or run the engine in a confined or partly enclosed area. Your engine's exhaust contains poisonous carbon monoxide, a colorless, odorless gas that can collect rapidly. Breathing carbon monoxide can cause loss of consciousness and may lead to death.

## WARNING

Exhaust contains poisonous carbon monoxide gas that can build up to dangerous levels in closed areas.

Breathing carbon monoxide can cause unconsciousness or death.

Never run this product's engine in a closed, or even partially closed area.

## BREAK-IN PROCEDURE

Proper break-in procedure allows the moving parts to wear in smoothly for best performance and long service life.

- First 15 minutes: Run the outboard motor at trolling speed. Use the minimum amount of throttle opening necessary to operate the boat at a safe trolling speed.
- Next 45 minutes: Run the outboard motor up to a maximum of 10% to 30% throttle opening.
- Next 60 minutes: Run the outboard motor up to maximum of 50% to 80% throttle opening. Short bursts of full throttle are acceptable but do not operate the outboard motor continuously at full throttle.
- Next 8 hours: Avoid continuous full throttle operation (100% throttle opening). Do not run the outboard motor at full throttle for more than 5 minutes at a time.

## TRANSOM ANGLE ADJUSTMENT

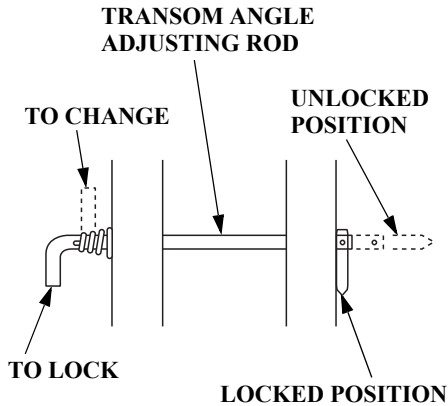

The transom angle adjusting rod is used to adjust the angle of the outboard motor in the normal operating position (p. 55).

1. To adjust, first tilt the outboard motor so it is not resting on the rod.
2. Push the rod in and turn the end of the rod up, so the latch will fall into line with the rod.
3. Remove the rod and reinsert it in the desired position.
4. Push the rod in and turn the end of the rod down, so the latch will fall to the locked position. Then release the rod.

## PRIMING THE CARBURETOR WITH GASOLINE (When using the internal fuel tank)

When starting the engine for the first time, or when starting the engine after the carburetor has been drained, the carburetor must be primed with gasoline before the engine will start. To prime the carburetor, remove the emergency stop switch clip from the outboard motor, and then pull the starter grip about 10 times.

### NOTICE

If you do not fill fuel to the upper level of the internal fuel tank, fuel loading to the carburetor may be insufficient.

# OPERATION

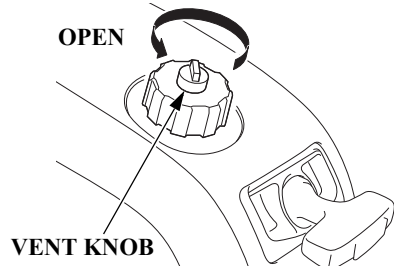

1. Fill the tank to the maximum fuel level (p.71).
2. Turn the internal fuel tank vent knob counterclockwise to the open position (p. 21).

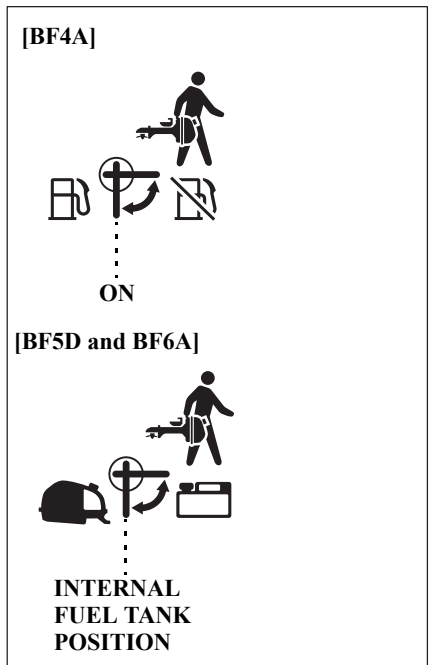
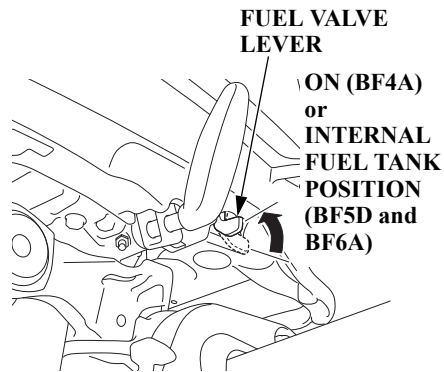

3. Turn the fuel valve lever to the ON position (BF4A) or internal fuel tank position (BF5D and BF6A) (p. 19).

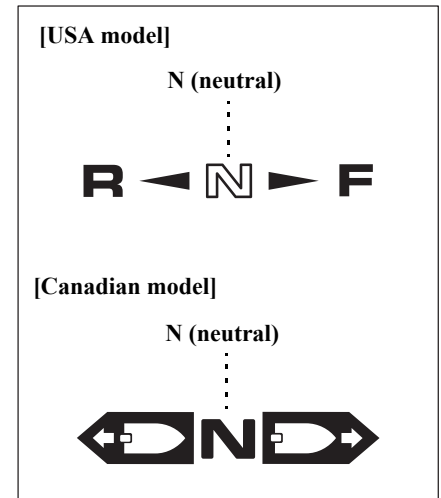
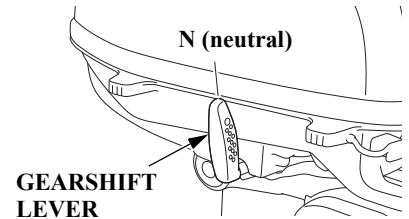

4. Check the position of the gearshift lever. It must be in the N (neutral) position for starting.

The recoil starter will not operate if the gearshift lever is in the F (forward) or R (reverse) position.

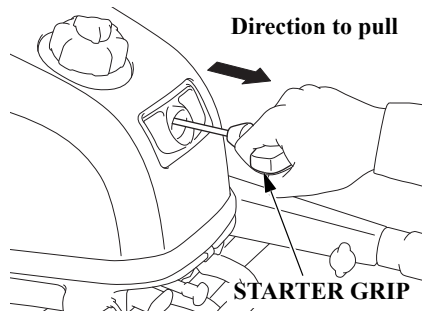

5. Pull the starter grip about 10 times.

Return the starter grip gently.

## PORTABLE FUEL TANK (OPTIONAL EQUIPMENT for BF5D and BF6A)

[When using the portable fuel tank]

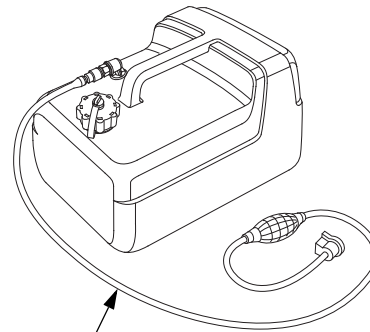

**FUEL HOSE**  
(standard equipment)

Place the portable fuel tank in a well-ventilated location, away from direct sunlight, to reduce the possibility of a gasoline vapor explosion.

To ensure that the outboard motor will be able to draw fuel from the tank, place the tank within 6 feet (2 m) of the outboard motor and not more than 3 feet (1 m) below the fuel connector on the outboard motor.

Secure the portable fuel tank in the boat so that it won't move around and become damaged.

### **⚠ WARNING**

Gasoline is highly flammable and explosive.

You can be burned or seriously injured when handling fuel.

- Stop the engine and let it cool before handling fuel.
- Keep heat, sparks, and flame away.
- Handle fuel only outdoors.
- Keep away from your vehicle.
- Wipe up spills immediately.

## OPERATION

### FUEL HOSE CONNECTIONS (OPTIONAL EQUIPMENT for BF5D and BF6A)

[When using the portable fuel tank]

Turn the portable fuel tank vent knob counterclockwise to the open position (p. 26) and remove the fuel hose connector cap.

#### FUEL HOSE CONNECTOR (FEMALE)

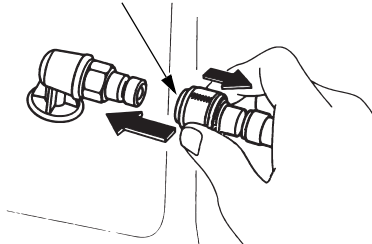

(FUEL TANK SIDE)

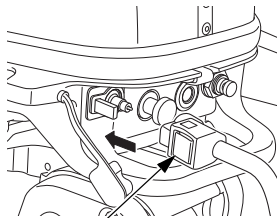

FUEL HOSE CONNECTOR (FEMALE)  
(OUTBOARD MOTOR SIDE)

Connect the fuel hose to the portable fuel tank and the outboard motor, as shown. Be sure both connectors snap securely into place. Always disconnect the fuel hose and install fuel inlet cap when tilting up the outboard motor, storing or transporting the outboard motor.

### FUEL PRIMING (OPTIONAL EQUIPMENT for BF5D and BF6A)

[When using the portable fuel tank]

Turn the portable fuel tank vent knob counterclockwise to the open position (p. 26) and turn the fuel valve lever to the portable fuel tank position (p. 19).

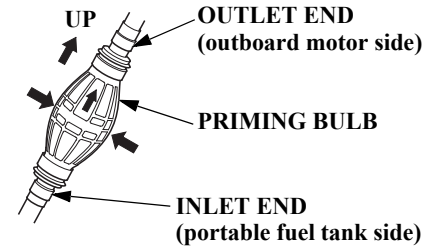

Hold the priming bulb up in the direction of the arrow; then squeeze the priming bulb several times until it feels firm, indicating that fuel has reached the carburetor.

Check to be sure there are no fuel leaks before starting the engine.

Do not touch the priming bulb with the engine running or when tilting up the outboard motor. The carburetor could overflow.

## INFREQUENT OR OCCASIONAL USE

If your outboard motor will be used on an infrequent or intermittent basis, please refer to the fuel section of the STORAGE chapter (p. 84) for additional information regarding fuel deterioration.

## STARTING THE ENGINE

Prime the carburetor with gasoline.

**(When using the internal fuel tank)**

When starting the engine for the first time after purchasing an outboard motor, or when starting the engine after draining the gasoline (p. 37).

**(When using the portable fuel tank)**

Connect the fuel line (p. 40) and prime the engine using the priming bulb (p. 40).

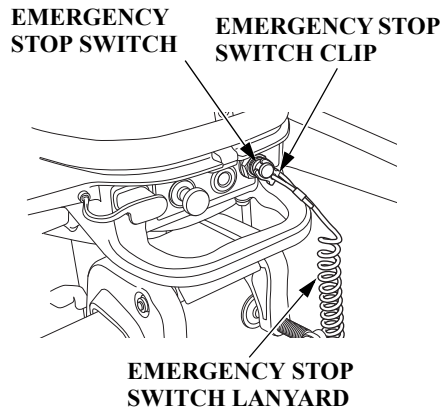

1. Put the emergency stop switch clip in the emergency stop switch, and attach the emergency stop switch lanyard securely to the operator or to the PFD (Personal Flotation Device) equipped to an operator.

The engine will not start or run unless the emergency stop switch clip is in the emergency stop switch.

The emergency stop switch clip and emergency stop switch lanyard system is a safety device that will stop the engine if you fall away from the controls while operating the boat.

Always attach the emergency stop switch lanyard securely to the operator or to the PFD equipped to an operator before starting the engine.

2. Connect the battery charge cable (equipped type) (p. 28).

# OPERATION

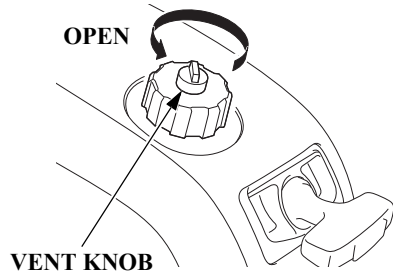

3. Turn the internal fuel tank vent knob counterclockwise to the open position (p. 21).

## NOTICE

*Always open the internal fuel filler cap vent knob when using the portable fuel tank.*

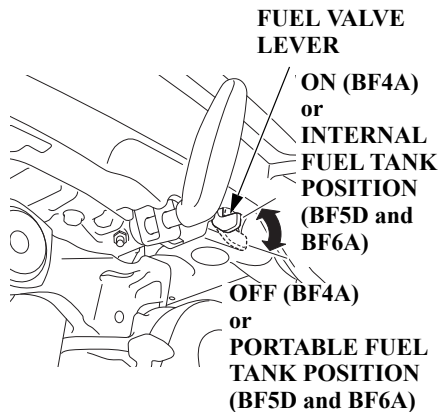

[BF4A]

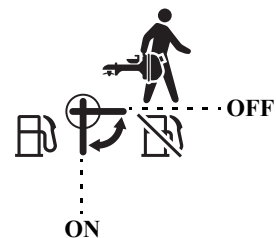

[BF5D and BF6A]

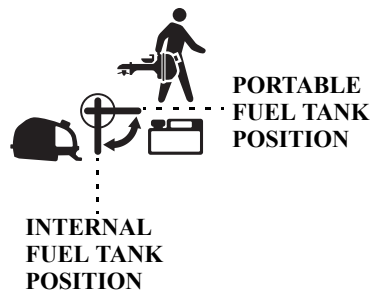



4. If you are using the internal fuel tank, turn the fuel valve lever to the ON position (BF4A) or internal fuel tank position (BF5D and BF6A) (p. 19).

If you are using the portable fuel tank, turn the fuel valve lever to the portable fuel tank position (BF5D and BF6A) (p. 19).

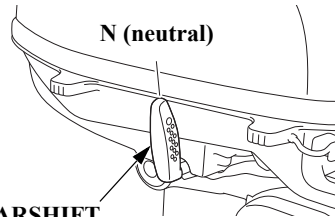

**GEARSHIFT  
LEVER**

[USA model]

N (neutral)

R ◀ N ▶ F

[Canadian model]

N (neutral)



5. Check the position of the gearshift lever. It must be in the N (neutral) position for starting.

The recoil starter will not operate if the gearshift lever is in the F (forward) or R (reverse) position.

# OPERATION

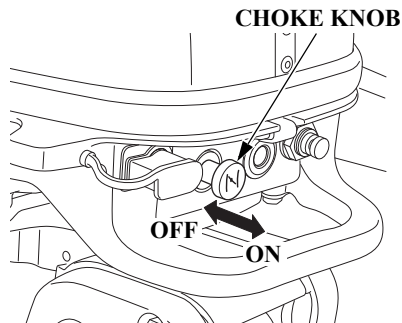

6. Pull the choke knob when the engine is in any of the following conditions:
- When the engine is cold or the outside temperature is low.
  - When restarting the engine after supplying fuel due to the internal fuel tank running out of fuel. In this case, when the engine starts, immediately return the choke knob to its original position.

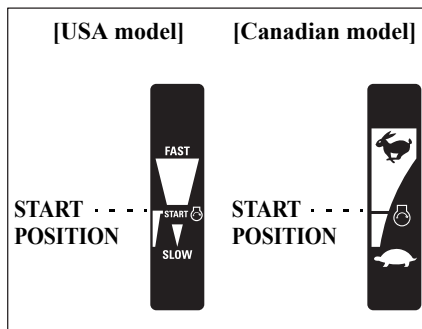
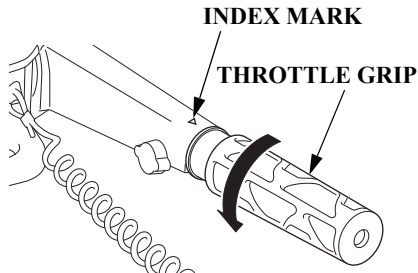

7. Align the START position with the index mark for starting the engine.

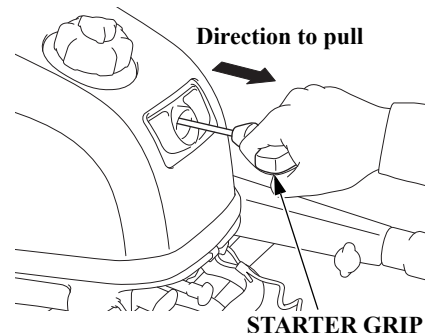

8. Pull the starter grip lightly until you feel resistance, then pull briskly in the direction of the arrow as shown above.

Return the starter grip gently.

9. If the choke knob was pulled to the ON position to start the engine, gradually push it to the OFF position as the engine warms up.

Also, as the engine warms up, the throttle grip can be turned to the SLOW position without stalling.

10. Before getting underway, allow the engine to warm-up sufficiently to ensure good performance.

During the warm-up period, check the oil pressure indicator (p. 24) and cooling system indicator (p. 25).

If the indicators show any abnormal condition, immediately stop the engine and determine the cause of the problem. Refer to *TAKING CARE OF UNEXPECTED PROBLEMS* on p. 94 and 97.

## EMERGENCY STARTING

If the recoil starter is inoperative, you can start the engine using the emergency starter rope that came with your outboard motor.

1. Connect the battery charge cable (equipped type) (p. 28).
2. Turn the internal fuel tank vent knob counterclockwise to the open position (p. 21).

### NOTICE

*Always open the internal fuel filler cap vent knob when using the portable fuel tank.*

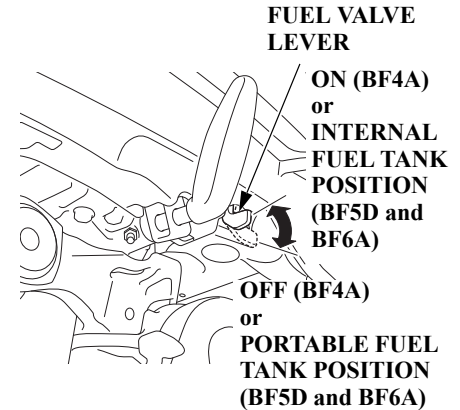

# OPERATION

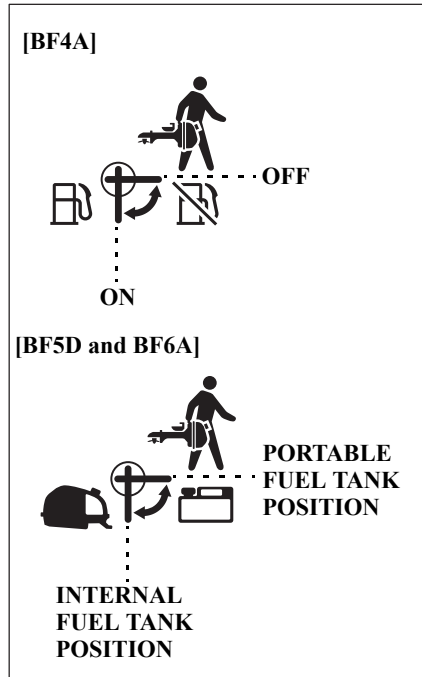

3. If you are using the internal fuel tank, turn the fuel valve lever to the ON position (BF4A) or internal fuel tank position (BF5D and BF6A) (p. 19).

If you are using the portable fuel tank, turn the fuel valve lever to the portable fuel tank position (BF5D and BF6A) (p. 19).

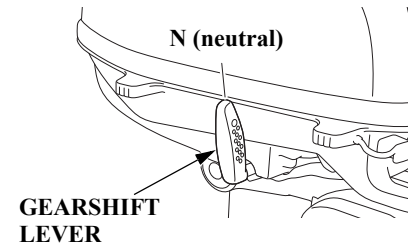

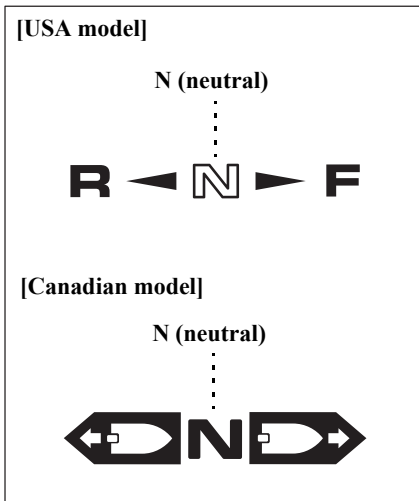

4. Move the shift lever to the N (neutral) position.
5. Unlock and remove the engine cover (p. 63).

**THROTTLE CABLES**

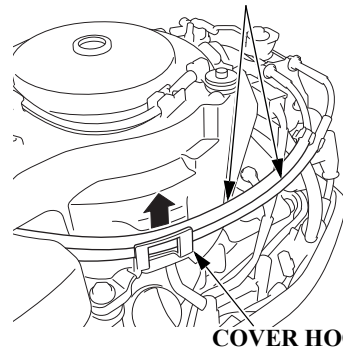

6. Release the throttle cables from the cover hook.

**COVER HOOK**

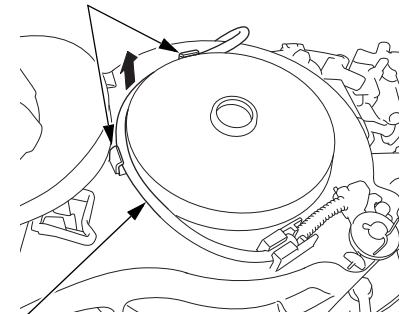

7. Release the neutral start cable from the cover hook.

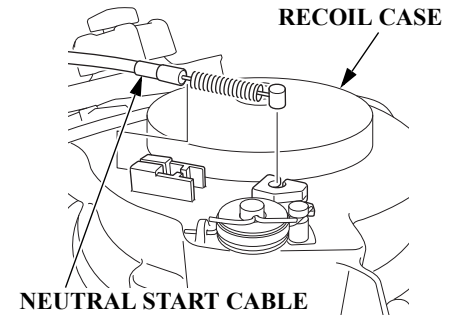

8. Disconnect the neutral start cable from recoil case.

## OPERATION

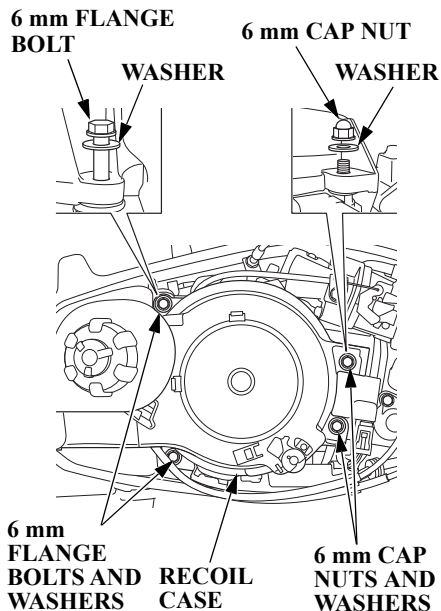

9. Remove the two 6 mm cap nuts, two washers, two 6 mm flange bolts and two washers, and remove the recoil case.

### NOTICE

*Take care not to lose the bolts, nuts and washers.*

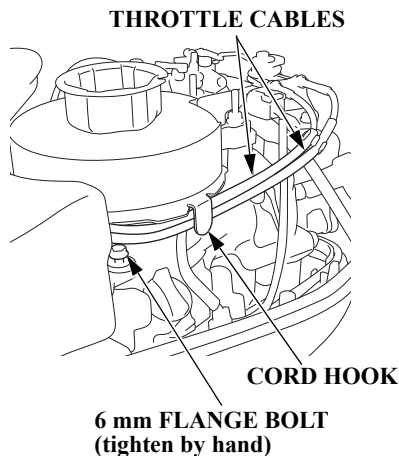

10. Install and tighten the 6 mm flange bolts by hand.
11. Hook the throttle cables to the cord hook.

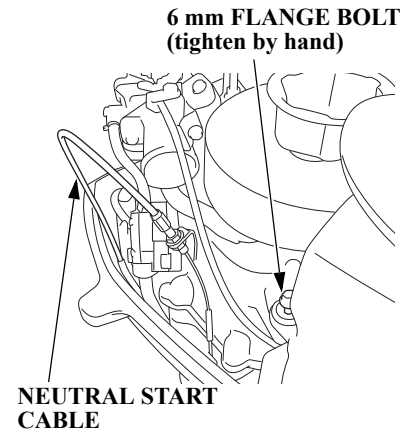

12. Hook the neutral start cable to the under case.
13. Make sure the shift lever is in the N (neutral) position.

The “Neutral Starting System” will not work in emergency starting. Be sure to set the shift lever into N (neutral) position to prevent start-in-gear when starting the engine in emergency. Sudden unexpected acceleration could result in serious injury or death.

# OPERATION

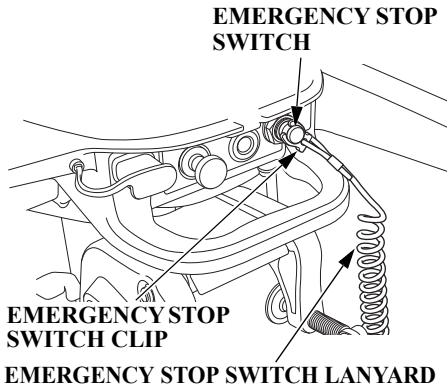

14. Put the emergency stop switch clip in the emergency stop switch, and attach the emergency stop switch lanyard securely to the operator or to the PFD (Personal Flotation Device) worn by the operator.

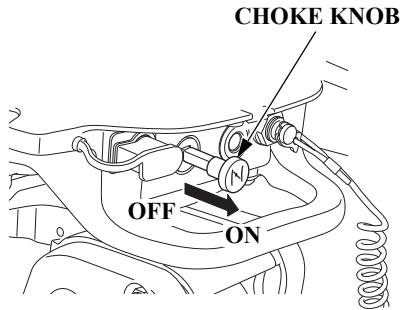

15. To start a cold engine, pull the choke knob to the ON position. To restart a warm engine, leave the choke knob in the OFF position.

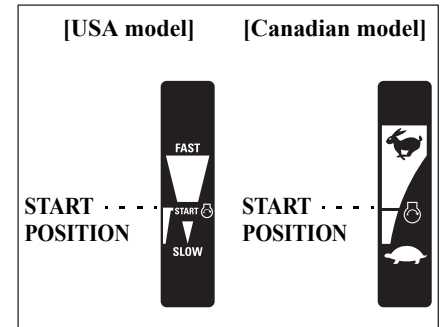
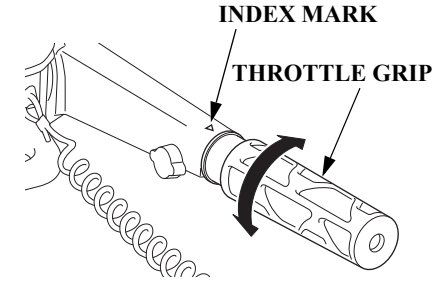

16. Align the START position with the index mark for starting the engine.

## OPERATION

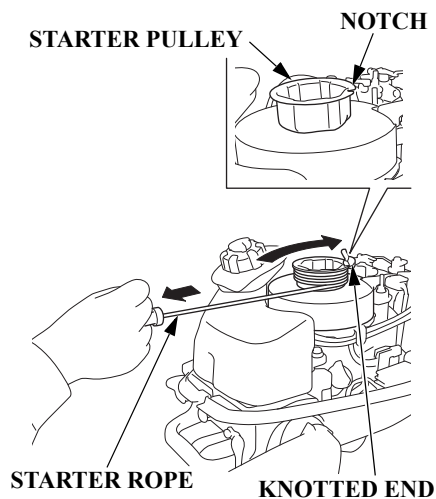

17. Set the knotted end of the emergency starter rope (provided with the engine) in the notch in the starter pulley. Wind the rope clockwise around the starter pulley.

18. Pull the emergency starter rope slowly until resistance is felt, then pull briskly.

Keep away from moving parts while pulling the rope.

If necessary, rewind the rope and pull again. If the engine does not start after several attempts, refer to *TAKING CARE OF UNEXPECTED PROBLEMS*, p. 91.

### **⚠ WARNING**

Exposed moving parts can cause injury.

- Do not operate the outboard motor without the engine cover.
- Use extreme care when installing the engine cover.

19. If the choke control was used to start the engine, return the control to the normal operating position as the engine warms up.

During the warm-up period, check the oil pressure indicator (p. 24), and cooling system indicator (p. 25).

20. Install the engine cover (p. 63), and lock it in place by locking the engine cover lock lever.

21. If it was necessary to remove the emergency stop switch lanyard from you to perform the emergency starting procedure, be sure the lanyard is attached securely to the operator before operating the outboard motor.

22. Have your closest authorized Marine dealer check your system and correct the problem, so you can use the recoil starter.



## STOPPING THE ENGINE

### Emergency Engine Stopping

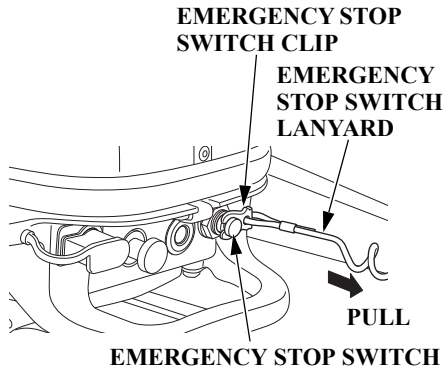

To stop the engine in an emergency, pull the emergency stop switch clip out of the emergency stop switch by pulling the emergency stop switch lanyard.

We suggest that you stop the engine this way occasionally to verify that the engine and emergency stop switch are operating properly.

### Normal Engine Stopping

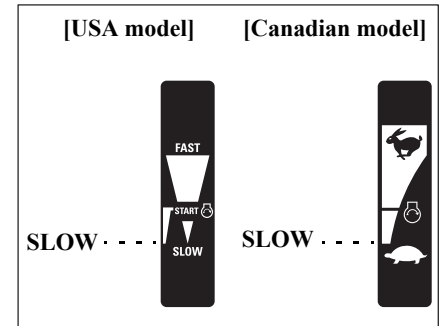
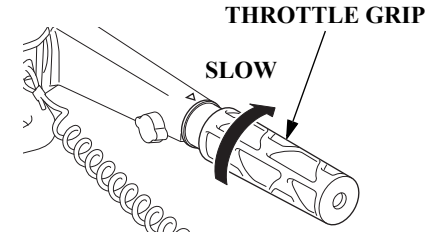

# OPERATION

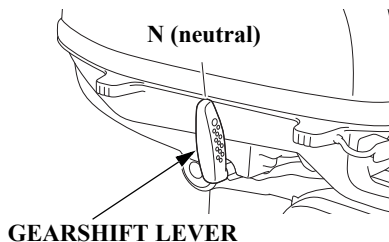

[USA model]

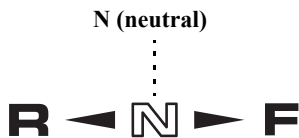

[Canadian model]

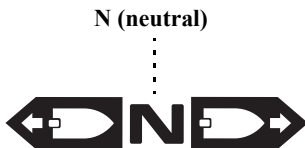

1. Move the throttle grip to the slowest speed and gearshift lever to the N (neutral) position.

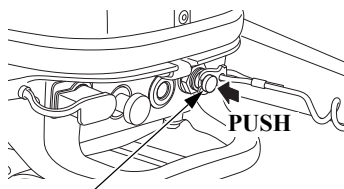

**EMERGENCY STOP SWITCH**

After cruising at full throttle, cool down the engine by idling for a few minutes before stopping the engine.

2. Press the emergency stop switch once to stop the engine.
3. Disconnect the battery charge cable (equipped type) (p. 29).

4. When the boat is not in use, remove and store the emergency stop switch clip and lanyard.

If you are using the internal fuel tank, turn the fuel valve lever to the OFF position (BF4A) or portable fuel tank position (BF5D and BF6A) (p. 19) and close the internal fuel tank vent by turning the vent knob clockwise all the way (p. 21).

If you are using a portable fuel tank, close the internal fuel tank vent by turning the vent knob clockwise all the way (p. 21) and close the portable fuel tank vent by turning the vent knob clockwise all the way (p. 26).

If you will be tilting up the outboard motor, storing or transporting the outboard motor, disconnect the fuel hose connectors from the outboard motor and portable fuel tank (p. 40), install fuel hose connector cap, close the internal fuel tank vent by turning the vent knob clockwise all the way (p. 21) and close the portable fuel tank vent by turning the vent knob clockwise all the way (p. 26).

## GEARSHIFTING AND THROTTLE OPERATION

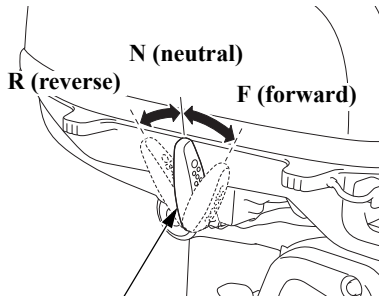
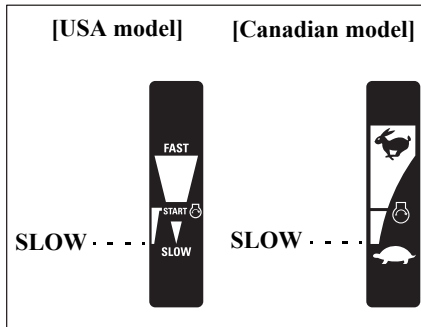
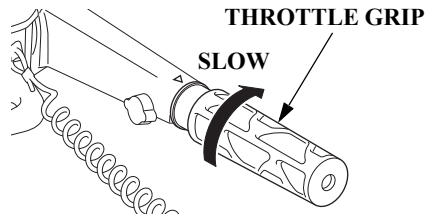

GEARSHIFT LEVER

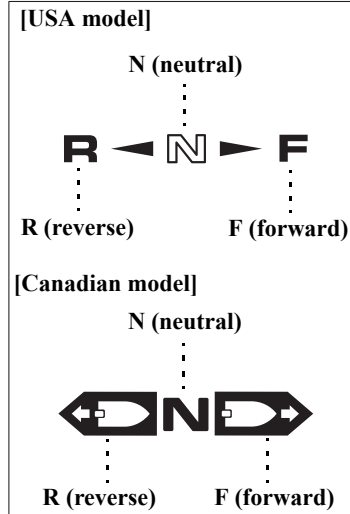

To shift gears, turn the throttle grip to the SLOW position; then move the gearshift lever to select the F (forward), N (neutral), or R (reverse) gears.

**NOTICE**

*Do not turn the throttle grip in the FAST direction in R (reverse) and N (neutral) gears.*

The recoil starter can be operated with the gearshift lever in the N (neutral) position only.

# OPERATION

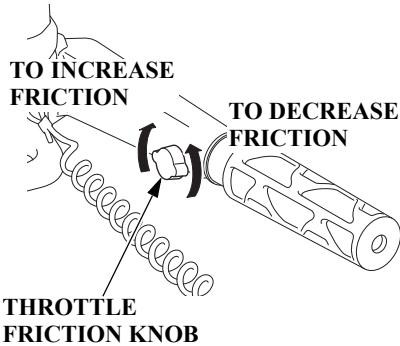

Use the throttle friction knob to help hold a constant throttle setting while cruising.

Turn the knob clockwise to increase throttle grip friction for holding a constant speed.

Turn the knob counterclockwise to decrease friction for easy grip rotation.

## STEERING

### RIGHT TURN



### LEFT TURN



Steer by moving the tiller handle opposite the direction you want the boat to turn.

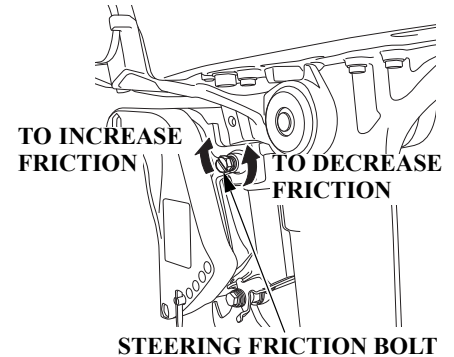

Use the steering friction bolt to help hold a steady course while cruising.

Turn the bolt clockwise to increase steering friction for holding a steady course.

Turn the bolt counterclockwise to decrease friction for easy turning.

## CRUISING

### Engine Speed

For best fuel economy, limit the throttle opening to 80%. Use the throttle friction control (p. 53) to help you hold a steady speed.

For rough water conditions or large waves, slow down to prevent the propeller from rising out of the water.

### Transom Angle

Install the outboard motor at the best transom angle for stable cruising and maximum power.

Transom angle too large: Causes boat to “squat.”

Transom angle too small: Causes boat to “bow steer.”

It is necessary to adjust the transom angle of the outboard motor to compensate for changes in boat load, weight distribution, water conditions, or propeller selection.

Under normal running conditions, the boat will perform best when the antiventilation plate is level with the water surface.

When cruising into a high wind, adjust the outboard motor down slightly to level the boat and improve stability. With a tail wind, adjust the outboard motor up slightly (p. 37).

### NOTICE

*Excessive transom angle during operation can cause propeller ventilation, overheating, and water pump damage. This type of damage is not covered by the Distributor's Limited Warranty (U.S.) / Distributor's Warranty (CA.) (p. 112).*

### Transom Angle (Cruising)

**OUTBOARD MOTOR ANGLE ADJUSTED TOO LOW**



**OUTBOARD MOTOR ANGLE ADJUSTED TOO HIGH**



**ROUGH WAVES**

**OUTBOARD MOTOR ANGLE ADJUSTED CORRECTLY**

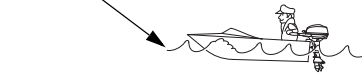

**CORRECT GIVES MAXIMUM PERFORMANCE**

## OPERATION

### SHALLOW WATER OPERATION

When operating in shallow water, tilt the outboard motor, using the tilt lever, so the propeller and gear case won't hit the bottom.

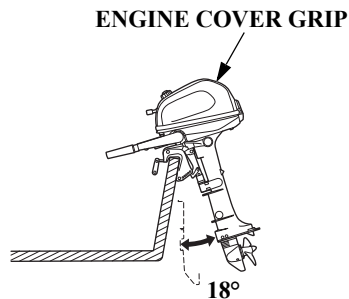

To tilt the outboard motor, raise the outboard motor to the 18° position by pulling on the engine cover grip.

#### NOTICE

*Do not use the tiller handle as a lever to raise the outboard motor. Applying excessive force to the tiller handle can damage it.*

While the outboard motor is tilted, proceed at a low speed, and do not operate the outboard motor in reverse. The outboard motor will rise suddenly if operated in reverse.

Monitor water flow from the cooling system indicator (p. 25) to be sure the outboard motor is not tilted so high that the water intakes are out of the water.

#### NOTICE

*An excessive tilt angle during operation can cause propeller ventilation, overheating, and water pump damage. This type of damage is not covered by the Distributor's Limited Warranty (U.S.) / Distributor's Warranty (CA.) (p. 112).*

ENGINE COVER GRIP

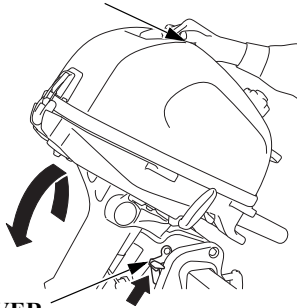

TILT LEVER

To return the outboard motor to the normal operating position, raise the outboard slightly by pulling on the engine cover grip, then pull the tilt lever to release the outboard, and then slowly lower the outboard motor.

## MOORING, BEACHING, LAUNCHING

Before tilting up, leave the outboard motor in the running position for one minute after stopping the engine to drain the water from inside the engine.

1. Move the shift lever to the N (neutral) position and stop the engine.
2. Turn the fuel valve lever to the OFF position (BF4A) or portable fuel tank position (BF5D and BF6A) (p. 19).
3. When using the portable fuel tank (BF5D and BF6A), disconnect the fuel hose connectors from the outboard motor and portable fuel tank (p. 40), install fuel hose connector cap and close the portable fuel tank vent by turning the vent knob clockwise all the way (p. 26).
4. Close the internal fuel tank vent by turning the vent knob clockwise all the way (p. 21).

ENGINE COVER GRIP

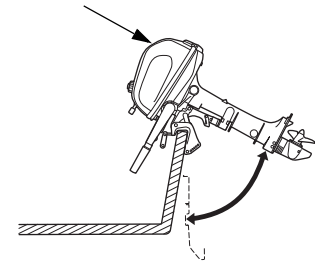

34°, 58° (when mooring)

To raise the outboard motor out of the water while the boat is moored, or for maximum clearance when beaching or launching, tilt the outboard motor to the 34° or 58° position.

Stop the engine before tilting the outboard motor. The 34° or 58° position is not an operating position.

Raise and lower the outboard motor as described on p. 56.

# SERVICING YOUR OUTBOARD MOTOR

## THE IMPORTANCE OF MAINTENANCE

Proper maintenance is essential for safe, economical, and trouble-free operation. It will also help reduce air pollution.

### **WARNING**

Failure to properly maintain this outboard motor, or failing to correct a problem before operation, could result in a significant malfunction.

Some malfunctions can cause serious injuries or death.

Always follow the inspection and maintenance recommendations and schedules in this owner's manual.

To help you properly care for your outboard motor, the following pages include a maintenance schedule, routine inspection procedures, and simple maintenance procedures using basic hand tools. Other service tasks that are more difficult or require special tools are best handled by professionals and are normally performed by a Honda technician or other qualified mechanic.

The maintenance schedule applies to normal operating conditions. If you operate your outboard motor under unusual conditions, consult an authorized Honda Marine dealer for recommendations applicable to your individual needs and use.

Remember that your authorized Honda Marine dealer knows your outboard motor best and is fully equipped to maintain and repair it.

To ensure the best quality and reliability, use only new, Honda Genuine parts or their equivalents for repair and replacement.

**Maintenance, replacement, or repair of the emission control devices and systems may be performed by any marine engine repair establishment or individual, using parts that are “certified” to EPA standards.**



## MAINTENANCE SAFETY

Some of the most important safety precautions follow. However, we cannot warn you of every conceivable hazard that can arise in performing maintenance. Only you can decide whether or not you should perform a given task.

### **WARNING**

Improper maintenance can cause an unsafe condition.

Failure to properly follow maintenance instructions and precautions can cause serious injuries or death.

Always follow the procedures and precautions in this owner's manual.

## Safety Precautions

- Make sure the engine is off before you begin any maintenance or repairs. This will eliminate several potential hazards:
  - **Carbon monoxide poisoning from engine exhaust.**  
Do not start or run the engine in a confined or partly enclosed area.
  - **Burns from hot parts.**  
Let the engine and exhaust system cool before touching.
  - **Injury from moving parts.**  
Do not run the engine unless instructed to do so.
- Read the instructions before you begin, and make sure you have the tools and skills required.
- To reduce the possibility of fire or explosion, be careful when working around gasoline. Use only a nonflammable solvent, not gasoline, to clean parts. Keep cigarettes, sparks, and flames away from all fuel-related parts.
- Wear gloves when handling the propeller to protect your hands from sharp edges.

# SERVICING YOUR OUTBOARD MOTOR

## TOOL KIT AND EMERGENCY STARTER ROPE

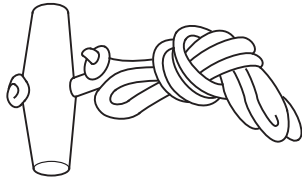

**EMERGENCY STARTER ROPE**

The following tools are supplied with the outboard motor for simple maintenance procedures and emergency repairs. An emergency starter rope is also supplied. Keep these items on the boat so that they will always be available if you need them.

If your tool kit needs replacement, it is not available as a kit and each item must be ordered individually.

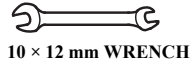

**10 × 12 mm WRENCH**



**FLAT SCREWDRIVER**



**PLIERS**

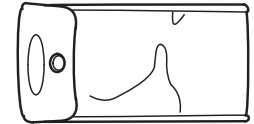

**TOOL BAG**

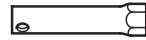

**SPARK PLUG  
WRENCH**

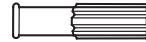

**GRIP**



**SPARE EMERGENCY  
STOP SWITCH CLIP**

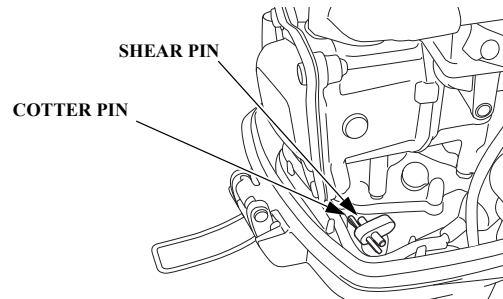

# SERVICING YOUR OUTBOARD MOTOR

## MAINTENANCE SCHEDULE

Follow the MAINTENANCE SCHEDULE table and service your outboard motor accordingly. Please note, a claim for warranty coverage will not be denied simply because the maintenance schedule for your outboard motor was not followed. However, any part(s) that fails specifically due to lack of maintenance, or improperly performed maintenance, would not be covered under the *Distributor's Limited Warranty (U.S.) / Distributor's Warranty (CA.)*.

REGULAR SERVICE PERIOD (3) Perform at every indicated month or operating hour interval, whichever comes first.		Each use	After use	First month or 20 hrs.	Every 6 months or 100 hrs.	Every year or 200 hrs.	Refer to page
ITEM							
Engine oil	Check level	o					64
	Change			o	o		65
Gear case oil	Change			o	o		67
Starter rope	Check				o		78
Carburetor linkage	Check-adjust			o (2)	o (2)		-
Valve clearance	Check-adjust			o (2)		o (2)	-
Spark plug	Check-adjust				o		70
	Replace					o	
Propeller and cotter pin	Check	o					79
Anode	Check	o (8)					35
Idling speed	Check-adjust			o (2)	o (2)		-
Lubrication	Grease			o (1)	o (1)		69

- (1) Lubricate more frequently when used in salt water.
- (2) These items should be serviced by your servicing dealer, unless you have the proper tools and are mechanically proficient. Refer to the Honda shop manual for service procedures. See "Honda Publications" on page 109 for ordering information.
- (3) For professional commercial use, log hours of operation to determine proper maintenance intervals.
- (8) When there is 1/3 or more consumption, please exchange.

# SERVICING YOUR OUTBOARD MOTOR

REGULAR SERVICE PERIOD (3) Perform at every indicated month or operating hour interval, whichever comes first.		Each use	After use	First month or 20 hrs.	Every 6 months or 100 hrs.	Every year or 200 hrs.	Refer to page
ITEM							
Fuel tank and tank filter (Internal)	Clean				o (2)		-
Fuel tank and tank filter (Portable)	Clean					o	77
Thermostat	Check					o (2)	-
Fuel filter	Check				o		75
	Replace					o	
Fuel line	Check	o (5)					35
	Replace		Every 2 years (If necessary) (2) (6)				
Bolts and nuts	Check-tightness			o (2)	o (2)		35
Breather tube	Check					o (2)	-
Cooling water passages	Clean		o (4)				81
Water pump	Check					o (2)	-
Emergency stop switch	Check	o					35
Engine oil leak	Check	o					-
Each operation part	Check	o					-
Engine condition (7)	Check	o					-

- (2) These items should be serviced by your servicing dealer, unless you have the proper tools and are mechanically proficient. Refer to the Honda shop manual for service procedures. See "Honda Publications" on page 109 for ordering information.
- (3) For professional commercial use, log hours of operation to determine proper maintenance intervals.
- (4) When operating in salt water, turbid or muddy water, the engine should be flushed with clean water after each use.
- (5) Check the fuel line for leaks, cracks or damage. If it is leaking, cracked or damaged, take it to your servicing dealer for replacement before using your outboard motor.
- (6) Check the fuel line for leaks, cracks or damage. Replace the fuel line if there are signs of leaks, cracks or damage.
- (7) Upon starting, check for unusual engine sounds and cooling water flowing freely from the check hole.

# SERVICING YOUR OUTBOARD MOTOR

## ENGINE COVER REMOVAL AND INSTALLATION

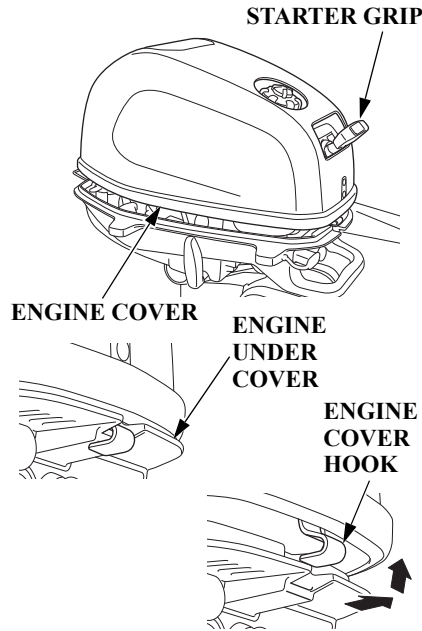
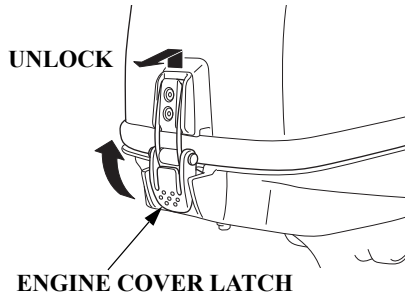

To remove, unlatch the engine cover latch and slide the engine cover forward. Unhook the engine cover hook as shown. Remove the engine cover while turning a starter grip to the upward.

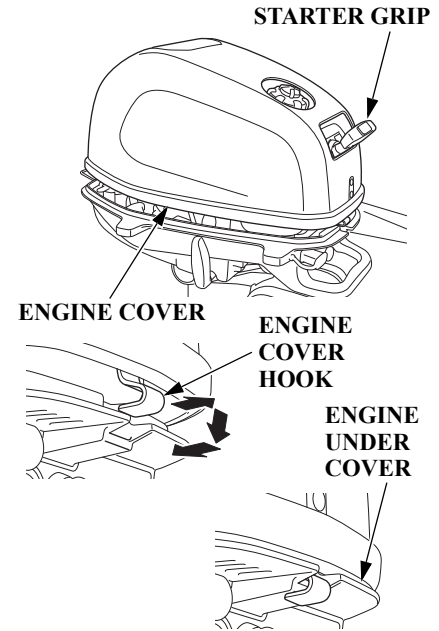

To install, lower the engine cover while turning a starter grip to the upward. Hook the engine cover hook as shown, and latch the engine cover latch.

# SERVICING YOUR OUTBOARD MOTOR

## Engine Oil Level Check

Check the engine oil level with the engine stopped and the outboard motor in the vertical position.

To avoid incorrect gauging of the engine oil level, inspect the oil level when the engine has cooled.

1. Unlock and remove the engine cover (p. 63).

2. Remove the oil filler cap/dipstick and wipe it clean.

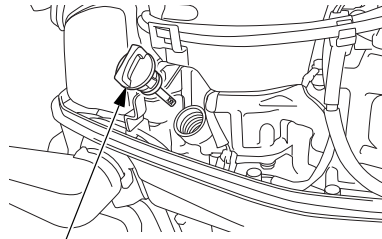

**OIL FILLER CAP/  
DIPSTICK**

3. Insert the dipstick and screw it in, then remove it and check the oil level shown on the dipstick.

**OIL FILLER CAP/  
DIPSTICK**

**UPPER LIMIT**

**LOWER LIMIT**

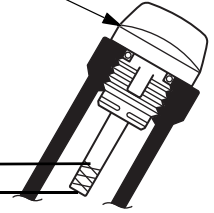

4. If the oil level is low, add oil to reach the upper limit mark shown on the dipstick. Use the oil recommended on p. 67.

### **NOTICE**

*Running the engine with a low oil level can cause engine damage.*

5. Install the oil filler cap/dipstick and tighten it securely.
6. Install the engine cover (p. 63), and lock it in place by locking the engine cover latch.

# SERVICING YOUR OUTBOARD MOTOR

When you check the oil level with the dipstick, you might notice the engine oil appears milky or the oil level has increased. If you notice either condition, change the engine oil. See the following table for an explanation of these conditions

Operating Method	Result	Effect
Running the engine below 3,000 rpm for more than 30% of the time so the engine does not warm up.	<ul style="list-style-type: none"><li>• Water condenses in the engine and mixes with the oil, resulting in a milky appearance.</li></ul>	The engine oil deteriorates, becomes less efficient as a lubricant, and causes an engine malfunction.
Frequent starting and stopping without allowing the engine to warm up.	<ul style="list-style-type: none"><li>• Unburned fuel mixes with the oil, increasing the volume of oil.</li></ul>	

## Engine Oil Change

An engine oil evacuation device may be used to remove the engine oil.

Drain the used oil into a suitable container while the engine is warm. Warm oil drains quickly and completely.

1. Unlock and remove the engine cover (p. 63).

# SERVICING YOUR OUTBOARD MOTOR

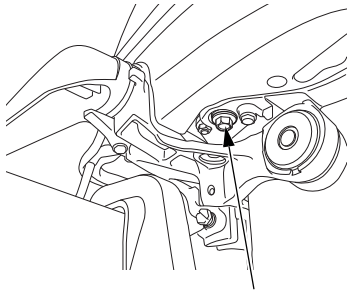

**DRAIN BOLT**

2. Remove the oil filler cap, and remove the engine oil drain bolt and washer.
3. Allow the used oil to drain completely, then reinstall the engine oil drain bolt and a new washer, and tighten it securely.

**ENGINE OIL DRAIN BOLT TORQUE:**  
24 lbf·ft (33 N·m, 3.4 kgf·m)

## **NOTICE**

*Improper disposal of engine oil can be harmful to the environment. If you change your own oil, please dispose of the used oil properly. Put it in a sealed container, and take it to a recycling center. Do not discard it in a trash bin, dump it on the ground, or pour it down a drain.*

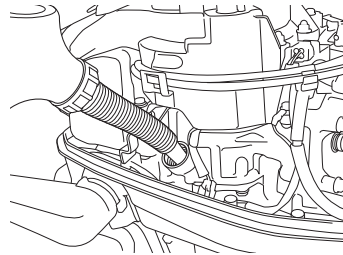

4. With the outboard in a vertical position, using the recommended oil, fill to the upper limit mark on the dipstick.

Insert the dipstick and screw it in, then remove it and check that oil level is shown on the dipstick upper limit mark.

**ENGINE OIL CAPACITY:**  
18 US oz (0.55 L, 0.48 Imp qt)

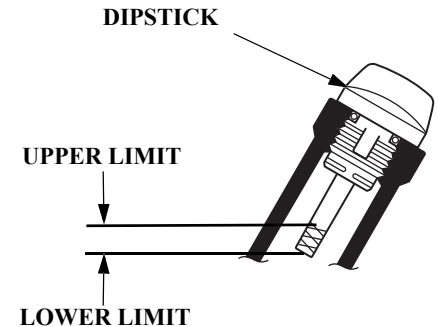

5. Install the oil filler cap and tighten it securely.
6. Install the engine cover (p. 63), and lock it in place by locking the engine cover latch.



# SERVICING YOUR OUTBOARD MOTOR

## Engine Oil Recommendations

Oil is a major factor affecting performance and service life.

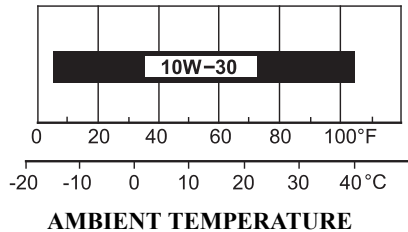

Honda recommends that you use API service category SG, SH or SJ oil. The SAE oil viscosity and service category are in the API label on the oil container.

## Gear Case Oil Change

Change the gear case oil with the engine stopped and the outboard motor in the vertical position.

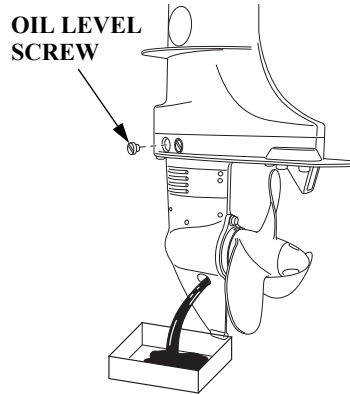

1. Place a suitable container below the oil drain hole to catch the used oil, then remove the oil level screw and oil drain/fill screw.

2. Allow the used oil to drain completely, then install an oil pump adapter in the oil drain hole.

If water or contaminated (milky-colored) oil flows out the drain hole when the screw is removed, have the outboard motor checked by an authorized Marine dealer.

# SERVICING YOUR OUTBOARD MOTOR

**OIL LEVEL  
SCREW**

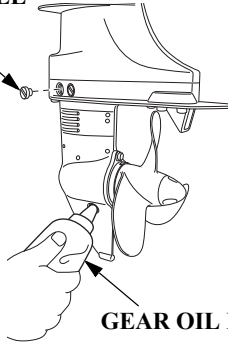

**GEAR OIL BOTTLE**

3. Add oil through the oil drain hole until it flows out the oil level hole, and then install the oil level screw. Remove the pump adapter and install the oil drain/fill screw.

**GEAR OIL CAPACITY:**

3 US oz (0.10 L, 0.09 Imp qt)

Outboard motor SAE 75W-90 or 90 hypoid gear oil API Service category (GL-4)

**OIL LEVEL SCREW TORQUE:**  
2.6 lbf·ft (3.5 N·m, 0.36 kgf·m)

Avoid losing more than 1 fl oz (30 cm<sup>3</sup>) while reinstalling the drain/ fill screw.

**OIL DRAIN SCREW TORQUE:**  
2.6 lbf·ft (3.5 N·m, 0.36 kgf·m)

# SERVICING YOUR OUTBOARD MOTOR

## Lubrication Points

Apply Honda Marine waterproof grease to the parts shown below:

Lubrication interval:

20 operating hours or one month after the date of purchase or the initial use, then every 100 operating hours or 6 months (refer to the maintenance schedule on page 61).

### NOTICE

*To prevent corrosion, apply anticorrosion oil to pivot surfaces where grease cannot penetrate.*

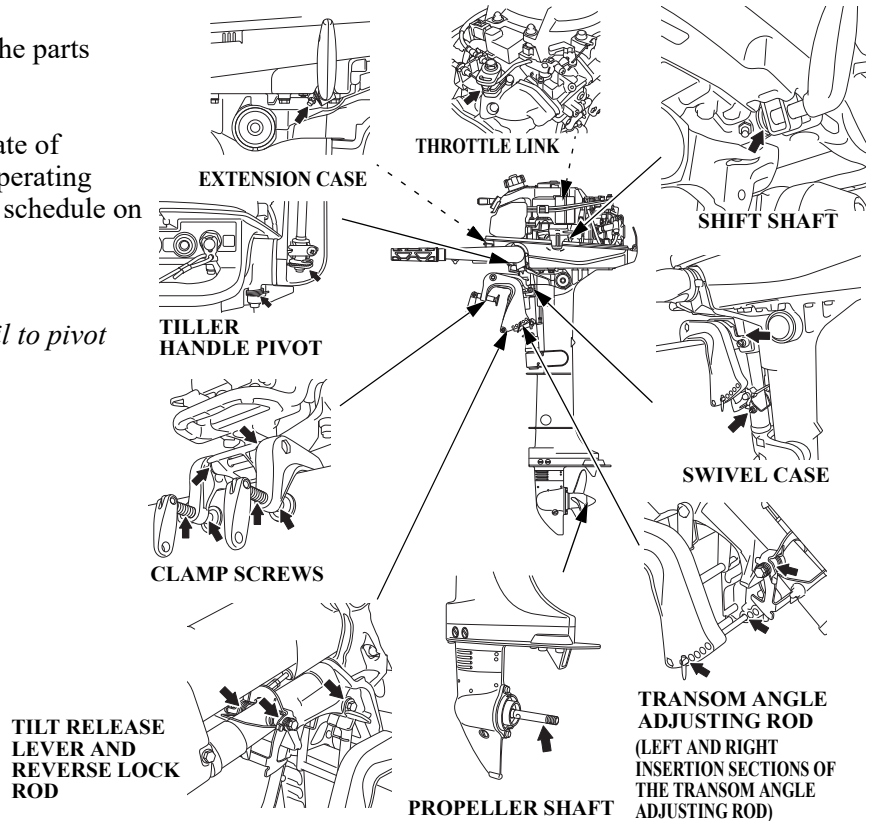

Apply Honda Marine Corrosion Inhibitor (or equivalent) to all areas under the engine cover and any exposed metal surfaces.

# SERVICING YOUR OUTBOARD MOTOR

## Spark Plug Service

RECOMMENDED SPARK PLUG:  
BKR6E-E (NGK)

### NOTICE

*Incorrect spark plug can cause engine damage.*

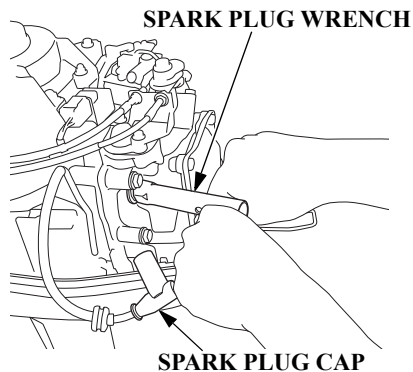

1. Unlock and remove the engine cover (p. 63).
2. Disconnect the spark plug cap from the spark plug.
3. Remove the spark plug with a spark plug wrench and screwdriver provided in the tool kit.

New plug

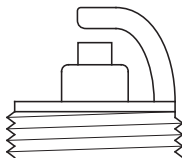

Plug needing replacement

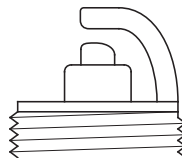

4. Inspect the spark plug. Replace it if the electrode is worn, or if the insulator is cracked or chipped.

SIDE ELECTRODE

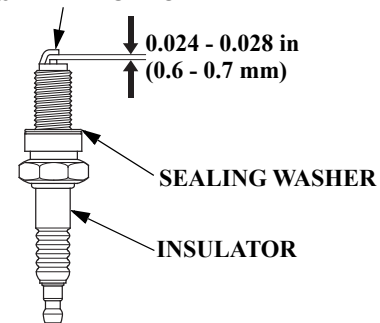

5. Measure the spark plug electrode gap with a wire-type feeler gauge. Correct the gap, if necessary, by carefully bending the side electrode.

The gap should be:  
0.024 - 0.028 in (0.6 - 0.7 mm)

# SERVICING YOUR OUTBOARD MOTOR

6. Install the spark plug carefully, by hand, to avoid cross-threading.
7. After the spark plug seats, tighten with a spark plug wrench to compress the sealing washer.

**SPARK PLUG TORQUE:**  
13 lbf·ft (18 N·m, 1.8 kgf·m)

If reinstalling the used spark plug, tighten 1/8 – 1/4 turn after the spark plug seats.

If installing new spark plug, tighten 1/2 turn after the spark plug seats.

## NOTICE

*A loose spark plug can overheat and damage the engine. Overtightening the spark plug can damage the threads in the cylinder head.*

8. Attach the spark plug cap.
9. Install the engine cover (p. 63), and lock it in place by locking the engine cover latch.

## REFUELING

If you do not anticipate using at least one complete tank of fuel within a 30 day period, we recommend adding Honda Marine Fuel Stabilizer or equivalent each time you refuel.

### Internal Fuel Tank

**FUEL TANK CAPACITY:**  
0.40 US gal (1.5 L, 0.33 Imp gal)

With the engine stopped, turn the internal fuel tank vent knob counterclockwise to the open position (p. 21), and then remove the fuel filler cap. Refill the fuel tank if the fuel level is low.

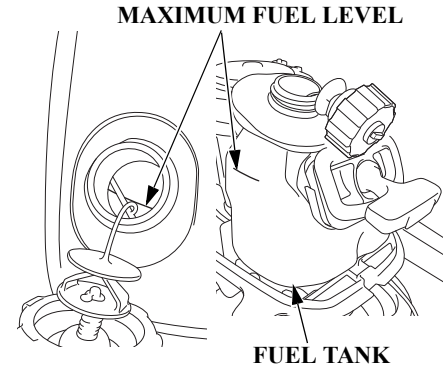
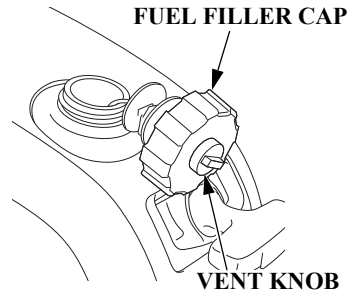

Refuel in a well-ventilated area. Fill the tank to the maximum fuel level.

After refueling, install the fuel filler cap and tighten it securely. Close the internal fuel tank vent by turning the vent knob clockwise all the way (p. 21).

## NOTICE

*Fuel can damage paint and plastic. Be careful not to spill fuel when filling your fuel tank. Damage caused by spilled fuel is not covered under the Distributor's Limited Warranty (U.S.) / Distributor's Warranty (CA.).*

# SERVICING YOUR OUTBOARD MOTOR

## **⚠ WARNING**

Gasoline is highly flammable and explosive.

You can be burned or seriously injured when handling fuel.

- Stop the engine and let it cool before handling fuel.
- Keep heat, sparks, and flame away.
- Handle fuel only outdoors.
- Keep away from your vehicle.
- Wipe up spills immediately.

Never refill the fuel tank inside a building where gasoline fumes may reach flames or sparks. Keep gasoline away from appliance pilot lights, barbecues, electric appliances, power tools, etc.

Spilled fuel is not only a fire hazard, it causes environmental damage. Wipe up spills immediately.

## **Portable Fuel Tank**

**FUEL TANK CAPACITY:**  
3.2 US gal (12 L, 2.6 Imp gal)

Check the fuel level. Refill the fuel tank if the fuel level is low.

Remove the fuel tank from the boat for refueling.

1. Turn the vent knob counterclockwise all the way to open the vent.

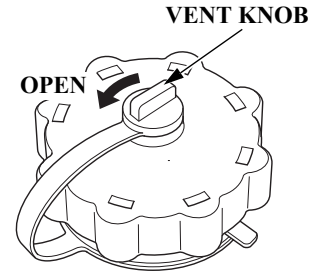

2. Turn the fuel filler cap counterclockwise so that it touches the pressure relief tab.

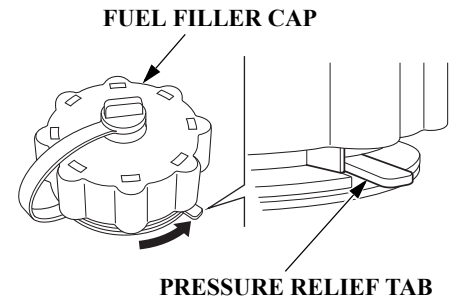

# SERVICING YOUR OUTBOARD MOTOR

3. Press down the pressure relief tab, and then turn the fuel filler cap 1/4 counterclockwise. Release the pressure relief tab. Wait to relieve pressure.

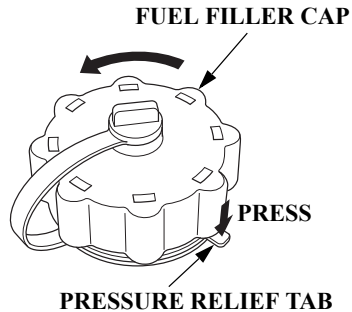

4. The fuel filler cap will lock again. Press down the pressure relief tab, and turn counterclockwise to remove the fuel filler cap.

Refuel in a well-ventilated area. Fill the tank to the SAFE FILL LEVEL line.

## SAFE FILL LEVEL

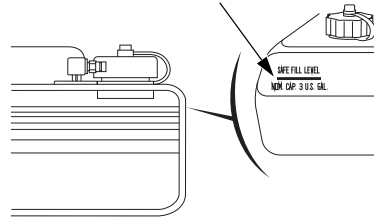

After refueling, install the cap and tighten it until you hear it click. Close the vent by turning the vent knob clockwise all the way, and return the fuel tank to the boat.

## FUEL FILLER CAP

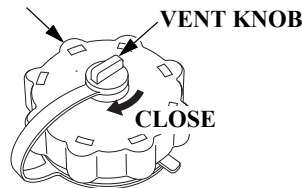

## NOTICE

*Fuel can damage paint and plastic. Be careful not to spill fuel when filling your fuel tank. Damage caused by spilled fuel is not covered under the Distributor's Limited Warranty (U.S.) / Distributor's Warranty (CA.).*

## ⚠ WARNING

Gasoline is highly flammable and explosive.

You can be burned or seriously injured when handling fuel.

- Stop the engine and let it cool before handling fuel.
- Keep heat, sparks, and flame away.
- Handle fuel only outdoors.
- Keep away from your vehicle.
- Wipe up spills immediately.

Never refill the fuel tank inside a building where gasoline fumes may reach flames or sparks. Keep gasoline away from appliance pilot lights, barbecues, electric appliances, power tools, etc.

Spilled fuel is not only a fire hazard, it causes environmental damage. Wipe up spills immediately.

# SERVICING YOUR OUTBOARD MOTOR

---

## FUEL RECOMMENDATIONS

**Use unleaded gasoline with a pump octane rating of 86 or higher.**

Your outboard motor is certified to operate on unleaded gasoline. Unleaded gasoline produces fewer engine and spark plug deposits and extends exhaust system life.

Never use gasoline that is stale, contaminated, or mixed with oil. Avoid getting dirt or water in the fuel tank.

You may use unleaded gasoline containing no more than 10% ethanol (E10) or 5% methanol by volume. In addition, methanol must contain cosolvents and corrosion inhibitors.

Use of fuels with content of ethanol or methanol greater than shown above may cause starting and/or performance problems. It may also damage metal, rubber, and plastic parts of the fuel system.

Engine damage or performance problems that result from using a fuel with percentages of ethanol or methanol greater than shown above are not covered under warranty.

If your outboard motor will be used on an infrequent or intermittent basis, please refer to the fuel section of the STORAGE chapter (p. 84) for additional information regarding fuel deterioration.



## Fuel Filter Inspection and Replacement

The fuel filter is located under the engine cover, on the right side of the engine.

Water or sediment accumulation in the filter can cause loss of power or hard starting. To prevent engine malfunction, inspect the filter and replace when necessary.

### **⚠ WARNING**

Gasoline is highly flammable and explosive.

You can be burned or seriously injured when handling fuel.

- Stop the engine and let it cool before handling fuel.
- Keep heat, sparks, and flame away.
- Handle fuel only outdoors.
- Keep away from your vehicle.
- Wipe up spills immediately.

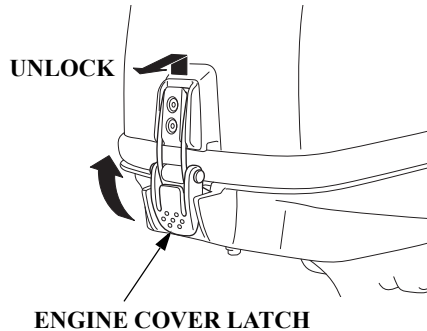

1. Unlock and remove the engine cover (p. 63).
2. Inspect the fuel filter for water and/or sediment accumulation.

If the fuel filter is OK, reinstall it. If water and/or sediment are present, replace the fuel filter as described in the following steps. Always replace the fuel filter at the scheduled replacement interval (p. 62).

3. Turn the fuel valve lever to the OFF position (BF4A) or portable fuel tank position (BF5D and BF6A) (p. 19).
4. When using the portable fuel tank (BF5D and BF6A), turn the portable fuel tank vent knob counterclockwise to the open position (p. 26), disconnect the fuel hose connectors from the outboard motor and portable fuel tank (p. 40), install fuel hose connector cap and close the portable fuel tank vent by turning the vent knob clockwise all the way (p. 26).
5. Close the internal fuel tank vent by turning the vent knob clockwise all the way (p. 21).

# SERVICING YOUR OUTBOARD MOTOR

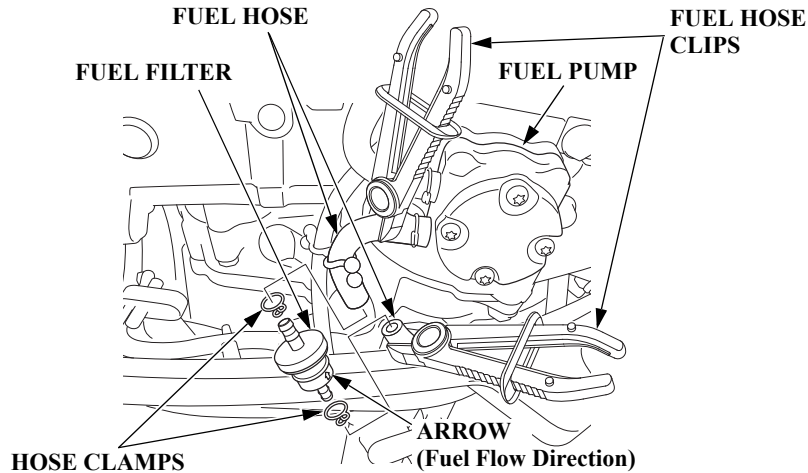

6. Place commercially available hose clips on the fuel hoses on each side of the fuel filter to prevent fuel leakage when the fuel hoses are disconnected.

7. Remove the fuel hoses from the used filter, and discard the filter.

To ease hose removal, release the hose clamps by squeezing the clamp ends together with pliers while pulling off the hoses.

8. Install the new fuel filter on the fuel hoses, with the fuel flow arrow pointing toward the fuel pump as shown. Fuel flow will be impeded if the fuel filter is installed backward.

9. Connect the fuel hoses to the fuel filter securely with the hose clamps.

10. Remove the fuel hose clips used to close the fuel hoses.

11. When using the internal fuel tank, prime the carburetor with gasoline (p. 37).

When using the portable fuel tank, connect the fuel line (p. 39) and prime the engine using the priming bulb (p. 40).

12. Check for fuel leaks. Repair any fuel leaks if necessary.

13. Install the engine cover (p. 63), and lock it in place by locking the engine cover latch.

If loss of power or hard starting are found to be caused by excessive water or sediment accumulation in the fuel filter, inspect the fuel tank.

Clean the fuel tank and tank filter if necessary. It may be necessary to drain the fuel tank completely and refill with fresh gasoline.

# SERVICING YOUR OUTBOARD MOTOR

## Portable Fuel Tank and Tank Filter Cleaning

(Optional Equipment for BF5D and BF6A)

### **⚠ WARNING**

Gasoline is highly flammable and explosive.

You can be burned or seriously injured when handling fuel.

- Stop the engine and let it cool before handling fuel.
- Keep heat, sparks, and flame away.
- Handle fuel only outdoors.
- Keep away from your vehicle.
- Wipe up spills immediately.

### *Fuel Tank*

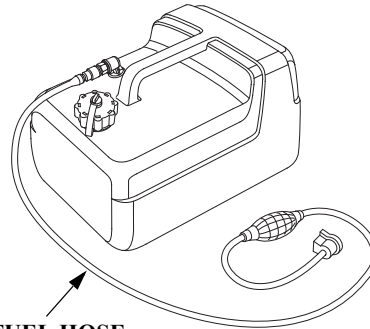

**FUEL HOSE**  
(standard equipment)

Empty the portable fuel tank into an approved gasoline container. Use a funnel to avoid spilling fuel. Rinse the fuel tank with nonflammable solvent to remove any accumulated sediment.

### *Fuel Tank Filter*

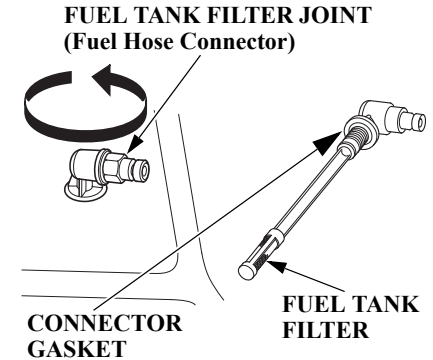

1. Turn the fuel tank filter joint counterclockwise and remove the fuel tank filter.
2. Clean the fuel tank filter in nonflammable solvent. Inspect the fuel tank filter and the connector gasket. Replace them if damaged.
3. After cleaning, reinstall the fuel tank filter and fuel tank filter joint securely.

# SERVICING YOUR OUTBOARD MOTOR

## Recoil Starter Rope Inspection

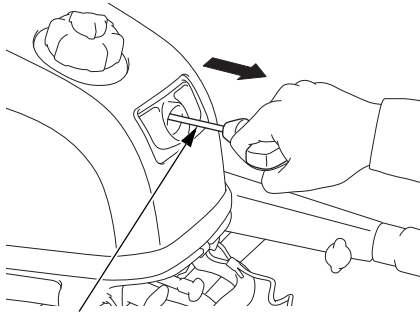

**RECOIL STARTER ROPE**

Inspect the recoil starter rope, and replace it if it becomes frayed.

Always keep the emergency starter rope on the boat in case the recoil starter rope fails.

## Anode Replacement

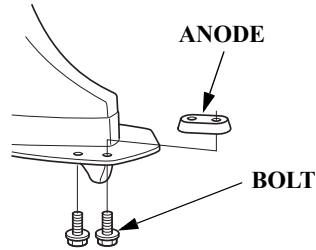

The anode is located on the antiventilation plate. It is made of a sacrificial material that helps to protect the outboard motor from corrosion.

Replace the anode when it has been reduced to about two-thirds of the original size, or if it is crumbling.

### **NOTICE**

*Painting or coating the anode will defeat its purpose and will lead to rust and corrosion damage to the outboard motor. The anode must be exposed to the water in order to protect the outboard motor.*

# SERVICING YOUR OUTBOARD MOTOR

## Propeller and Shear Pin Replacement

A shear pin is used to protect the propeller and drive mechanism from damage when the propeller strikes an obstruction.

If the propeller is damaged by striking a rock, or other obstacle, replace the propeller.

Before replacing the propeller or the shear pin, remove the emergency stop switch clip from the emergency stop switch to prevent any possibility of the engine being started while you are working with the propeller.

The propeller blades may have sharp edges, so wear heavy gloves to protect your hands.

Operating the outboard motor at higher altitudes will reduce available power. This may require decreasing the propeller pitch to maintain correct engine RPM.

## Removal

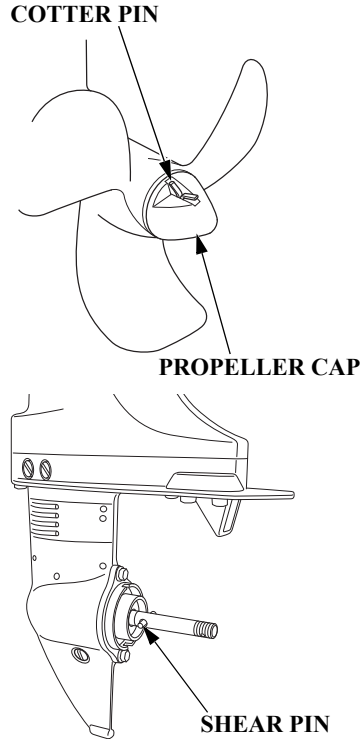

1. Remove the cotter pin, the propeller cap, and the propeller.
2. Remove the broken shear pin and replace it with a new one.

# SERVICING YOUR OUTBOARD MOTOR

---

## *Installation*

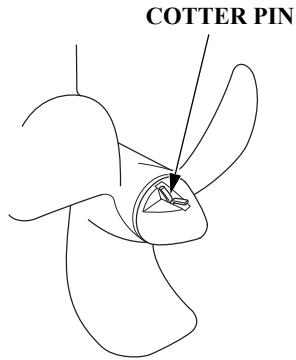

1. Install the shear pin and the propeller, then install the propeller cap finger tight.
  2. Be sure to replace the cotter pin with a new one.
- Use a Honda Genuine stainless steel cotter pin or equivalent cotter pin and bend the pin ends as shown.

Spare shear pin and cotter pin are provided in the engine compartment (p. 60).

# CLEANING AND FLUSHING

## Cleaning and Flushing

After each use in salt water or dirty water, thoroughly clean and flush the outboard motor with fresh water.

## Cleaning

Wash the outside of the outboard motor with clean, fresh water to remove mud, salt, seaweed, etc.

Disengage the emergency stop switch clip from the emergency stop switch, and pull the recoil starter rope several times to expel any water remaining in the water pump.

Touch up any damaged paint, and coat areas that may rust with Honda Corrosion Inhibitor, or equivalent. Lubricate controls with a silicone spray lubricant.

## *Flushing With the Honda Water Hose Connector*

1. Tilt down the outboard motor (p. 56).

### **FLUSH KIT (Optional Equipment)**

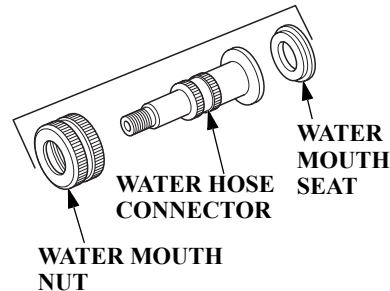

2. Remove the flush screw from the WASH screw hole and install the water hose connector.
3. Attach a hose from a fresh water faucet to the water hose connector of the flush kit.

4. Remove the propeller (p. 79).
5. Turn on the fresh water supply to hose.
6. Start the engine and run in N (neutral) for 10 minutes.

## CLEANING AND FLUSHING

---

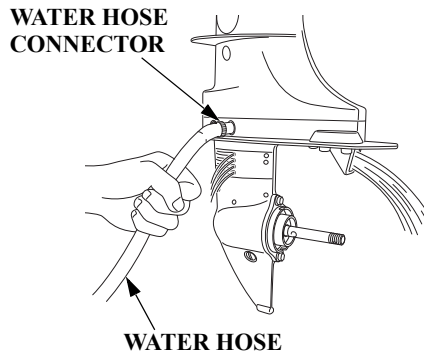

7. After flushing, when using the internal fuel tank, close the internal fuel tank vent by turning the vent knob clockwise all the way (p. 21), turn the fuel valve lever to the OFF position (BF4A) or portable fuel tank position (BF5D and BF6A) (p. 19) and leave the outboard motor in the running position for one minute to drain the water from inside the engine.

After flushing, when using the portable fuel tank (BF5D and BF6A), turn the portable fuel tank vent knob counterclockwise to the open position (p. 26), disconnect the fuel hose connectors from the outboard motor and portable fuel tank (p. 40), install fuel hose connector cap, close the internal fuel tank vent by turning the vent knob clockwise all the way (p. 21), close the portable fuel tank vent by turning the vent knob clockwise all the way (p. 26) and leave the outboard motor in the running position for one minute to drain the water from inside the engine.

8. Reinstall the flush screw and the propeller (p. 80).
9. Tilt up the outboard motor (p. 57).



### *Flushing Without the Honda Water Hose Connector*

It is necessary to run the engine during the flushing procedure. For safety, remove the propeller from the outboard motor (p. 79).

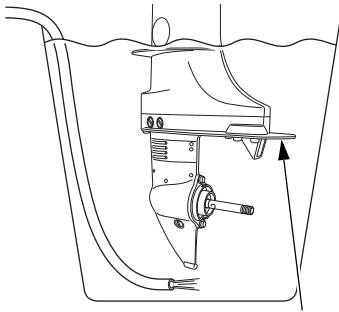

ANTIVENTILATION PLATE

1. Tilt down the outboard motor (p. 56).
2. Place a container under the outboard motor, and fill it with clean, fresh water. The water level must be at least 2 inches (5 cm) above the antiventilation plate.

#### **NOTICE**

*Running the engine without good water circulation can cause overheating and water pump damage.*

Damage caused by running the outboard motor without sufficient cooling water is not covered by the *Distributor's Limited Warranty (U.S.) / Distributor's Warranty (CA.)* (p. 112).

3. Start the engine and run in the N (neutral) position at low speed for at least 10 minutes.
4. After flushing, when using the internal fuel tank, close the internal fuel tank vent by turning the vent knob clockwise all the way (p. 21), turn the fuel valve lever to the OFF position (BF4A) or portable fuel tank position (BF5D and BF6A) (p. 19) and leave the outboard motor in the running position for one minute to drain the water from inside the engine.

After flushing, when using the portable fuel tank (BF5D and BF6A), turn the portable fuel tank vent knob counterclockwise to the open position (p. 26), disconnect the fuel hose connectors from the outboard motor and portable fuel tank (p. 40), install fuel hose connector cap, close the internal fuel tank vent by turning the vent knob clockwise all the way (p. 21), close the portable fuel tank vent by turning the vent knob clockwise all the way (p. 26) and leave the outboard motor in the running position for one minute to drain the water from inside the engine.

5. Reinstall the propeller (p. 80).
6. Tilt up the outboard motor (p. 57).

# STORAGE

## Fuel

### NOTICE

*Depending on the region where you operate your outboard, fuel formulations may deteriorate and oxidize rapidly. Fuel deterioration and oxidation can occur in as little as 15 days and may cause damage to the carburetor and fuel system.*

*Please check with your servicing dealer for local storage recommendations.*

Gasoline will oxidize and deteriorate in storage. Deteriorated gasoline will cause hard starting, and it leaves gum deposits that clog the fuel system. If the gasoline in your fuel tank and carburetor deteriorates during storage, you may need to have the carburetor and other fuel system components serviced or replaced.

The length of time that gasoline can be left in your fuel tank and carburetor without causing functional problems will vary with such factors as gasoline blend, your storage temperatures, and whether the fuel tank is partially or completely filled. The air in a partially filled fuel tank promotes fuel deterioration. Very warm storage temperatures accelerate fuel deterioration. Fuel deterioration problems may occur in less than 15 days, if the gasoline was not fresh when you filled the fuel tank.

You can extend fuel storage life by adding a gasoline stabilizer that is formulated for that purpose, or you can avoid fuel deterioration problems by draining all the fuel from the fuel tank and carburetor.

*The Distributor's Limited Warranty (U.S.) / Distributor's Warranty (CA.)* (p. 112) does not cover fuel system damage or engine performance problems resulting from neglected storage preparation.

### ***Adding a Fuel Stabilizer***

When adding a fuel stabilizer, fill the internal fuel tank with fresh gasoline. If only partially filled, air in the internal fuel tank will promote fuel deterioration during storage. If you keep an additional container of gasoline for refueling, be sure that it contains only fresh gasoline.

1. Add Honda Marine fuel stabilizer or equivalent following the instructions on the label.
2. After adding a fuel stabilizer, run the engine in water for 10 minutes to be sure that the treated gasoline has replaced the untreated gasoline in the carburetor.
3. Stop the engine (p. 51).

## *Draining the Fuel System*

You can avoid fuel deterioration problems by draining the fuel tank and carburetor.

1. When using the portable fuel tank (BF5D and BF6A), turn the portable fuel tank vent knob counterclockwise to the open position (p. 26), disconnect the fuel hose connectors from the outboard motor and portable fuel tank (p. 40), install fuel hose connector cap, remove the portable fuel filler cap, drain the gasoline from the portable fuel tank into a suitable container, install the portable fuel filler cap and close the portable fuel tank vent by turning the vent knob clockwise all the way (p. 26).

## **⚠ WARNING**

Gasoline is highly flammable and explosive.

You can be burned or seriously injured when handling fuel.

- Stop the engine and let it cool before handling fuel.
- Keep heat, sparks, and flame away.
- Handle fuel only outdoors.
- Keep away from your vehicle.
- Wipe up spills immediately.

2. Turn the internal fuel tank vent knob counterclockwise to the open position (p. 21), remove the fuel filler cap, and drain the gasoline from the internal fuel tank into a suitable container.
3. Install the fuel filler cap.
4. Turn the fuel valve lever to the OFF position (BF4A) or portable fuel tank position (BF5D and BF6A) (p. 19).

5. Unlock and remove the engine cover (p. 63).

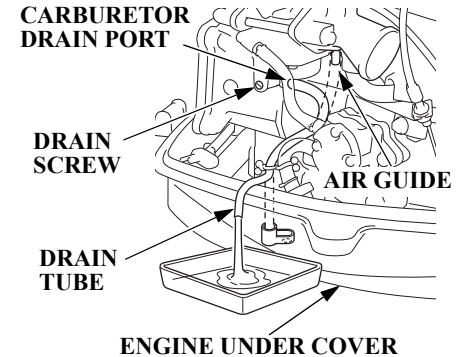

6. Disconnect the drain tube from the air guide, then connect it to the carburetor drain port as shown.
7. With the outboard motor in a vertical position, place an approved gasoline container below the fuel drain outlet, and use a funnel to avoid spilling fuel. Loosen the drain screw to drain fuel from the carburetor.

## STORAGE

---

8. After the fuel has drained from the carburetor, tighten the drain screw securely.
9. Reconnect the drain tube to the air guide and the engine under cover.
10. Close the internal fuel tank vent by turning the vent knob clockwise all the way (p. 21).
11. Turn the fuel valve lever to the OFF position (BF4A) or portable fuel tank position (BF5D and BF6A) (p. 19).

12. If you need to store fuel in the fuel tank, you can extend fuel storage life by filling the fuel tank with fresh gasoline and adding Honda Marine fuel stabilizer or equivalent following the directions on the container (p. 84).

Store the portable fuel tank in a cool dry place out of direct sunlight.

### **(When using the internal fuel tank)**

When starting the engine after draining the gasoline, prime the carburetor with gasoline (p. 37).

### **Engine Oil**

Change the engine oil (p. 65).

### **Engine Cylinder**

1. Remove the spark plug (p. 70), and remove the emergency stop switch clip from the emergency stop switch.
2. Pour 1 – 2 teaspoons (5 – 10 cm<sup>3</sup>) of clean engine oil into the cylinder.
3. Pull the starter grip several times to distribute the oil in the cylinder.

#### **NOTICE**

*When cranking the engine with an open ignition circuit (spark plug removed from the ignition circuit), remove the emergency stop switch clip from the emergency stop switch to prevent possible damage to the ignition system.*

4. Reinstall the spark plug and connect the spark plug cap (p. 71).
5. Install the engine cover (p. 63), and lock it in place by locking the engine cover latch.

**STORAGE PRECAUTIONS**

Select a well-ventilated storage area. If possible, avoid storage areas with high humidity.

Disconnect the battery charge cable (equipped type) (p. 29).

**CARRYING HANDLE**

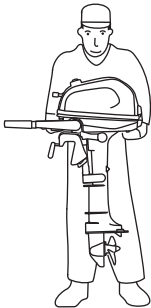
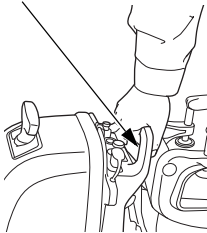

To carry the outboard motor, hold it by the carrying handle, or hold by the carrying handle and the lug beneath the engine under cover, as shown.

**NOTICE**

*Lifting the outboard motor by the engine cover, or using the installed outboard motor as a handle or lever to move the boat, can damage the outboard motor.*

If your internal fuel tank and portable fuel tank contains gasoline, store it away from any appliance that operates with a flame, such as a furnace, water heater, or clothes dryer. Also avoid any area with a spark-producing electric motor, or where power tools are operated.

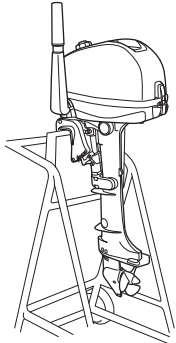

Store the outboard motor either vertically or horizontally with the tiller handle side up and move the shift lever to the R (reverse) position to lock the tilt system.

## STORAGE

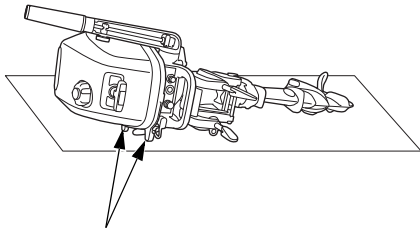

**CASE PROTECTORS**

If storing horizontally, be sure to fold the tiller handle, and rest the outboard motor on its case protectors.

Be sure all water has drained from the outboard motor before placing it on its side, so no residual water can enter the engine exhaust port.

### NOTICE

- *Any other horizontal storage position may cause damage to the outboard motor or oil leakage.*
- *Position the outboard motor so that the engine side is higher than the propeller side. Failure to do so may cause engine oil leakage.*

Cover the outboard motor to keep out dust. Do not use a plastic sheet as a dust cover. A nonporous cover will trap moisture, promoting rust and corrosion.

### REMOVAL FROM STORAGE

Check your outboard motor as described in the *BEFORE OPERATION* chapter of this manual.

If the cylinder was coated with oil during storage preparation, the engine may smoke briefly at startup. This is normal.

## WITH OUTBOARD MOTOR INSTALLED ON BOAT

When using the portable fuel tank (BF5D and BF6A), turn the portable fuel tank vent knob counterclockwise to the open position (p. 26), disconnect the fuel hose connectors from the outboard motor and portable fuel tank (p. 40), install fuel hose connector cap and close the portable fuel tank vent by turning the vent knob clockwise all the way (p. 26).

Drain the internal fuel tank and carburetor as described on p. 85, turn the fuel valve lever to the OFF position (BF4A) or portable fuel tank position (BF5D and BF6A) (p. 19), close the internal fuel tank vent by turning the vent knob clockwise all the way (p. 21), move the shift lever to the R (reverse) position to lock the tilt system and tighten the steering friction bolt securely (p. 54).

The preferred method is to leave the engine in the normal running position, but if there is insufficient road clearance, you can tilt the outboard motor using a commercially available outboard motor support bar available through your dealer. Refer to the manufacturer's instructions for using an outboard motor support bar.



**OUTBOARD MOTOR SUPPORT BAR**  
(commercially available)

## TRANSPORTING

### WITH OUTBOARD MOTOR REMOVED FROM BOAT

Disconnect the battery charge cable (equipped type) (p. 29).

When using the portable fuel tank (BF5D and BF6A), turn the portable fuel tank vent knob counterclockwise to the open position (p. 26), disconnect the fuel hose connectors from the outboard motor and portable fuel tank (p. 40), install fuel hose connector cap and turn the portable fuel tank vent knob clockwise all the way (p. 26).

Drain the internal fuel tank and carburetor as described on p. 85, turn the fuel valve lever to the OFF position (BF4A) or portable fuel tank position (BF5D and BF6A) (p. 19), close the internal fuel tank vent by turning the vent knob clockwise all the way (p. 21), move the shift lever to the R (reverse) position to lock the tilt system and tighten the steering friction bolt securely (p. 54).

Remove the outboard motor from the boat and secure the outboard motor in either the vertical or horizontal position shown on p. 88.

#### CARRYING HANDLE

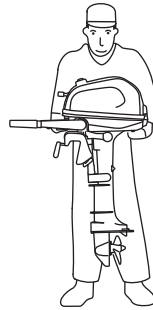
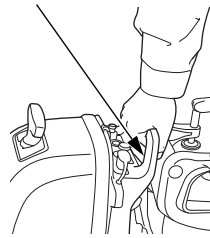

To carry, hold the outboard motor by the carrying handle, or hold by the carrying handle and the lug beneath the engine under cover, as shown.

#### NOTICE

*Lifting the outboard motor by the engine cover, or using the installed outboard motor as a handle or lever to move the boat, can damage the outboard motor.*



# TAKING CARE OF UNEXPECTED PROBLEMS

## ENGINE WILL NOT START

Possible Cause	Correction
Clip not inserted in emergency stop switch.	Insert clip in emergency stop switch.
Gearshift lever not in neutral position.	Shift to neutral (p. 41).
Choke OFF.	Pull choke knob to ON position, unless engine is warm (p. 44).
Throttle grip not in START position.	Turn throttle grip to START position (p. 44).
Engine ran out of fuel.	Refill fuel tank (p. 71). Perform the priming procedure after refilling the tank (p. 37). Pull choke knob (p. 44).
Engine is at negative trim angle.	Tilt the engine up to the first shallow water drive position (p. 56). Return engine to normal operating position after starting (p. 57).

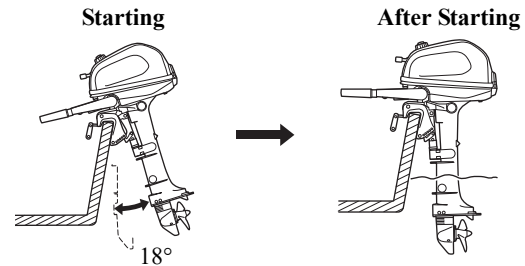
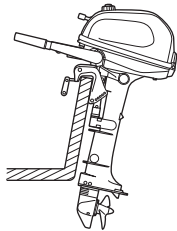

## TAKING CARE OF UNEXPECTED PROBLEMS

---

### ENGINE WILL NOT START

Possible Cause	Correction
Out of fuel.	Refuel (p. 71).
Fuel valve lever is not turned to the appropriate position.	Turn the fuel valve lever to the appropriate position (p. 19).
Fuel vent closed (internal fuel tank).	Turn the internal fuel tank vent knob counterclockwise to the open position (p. 21).
When using the portable fuel tank (BF5D and BF6A), fuel vent closed (portable fuel tank).	Turn the portable fuel tank vent knob counterclockwise to the open position (p. 26).
When using the portable fuel tank (BF5D and BF6A), fuel hose not primed.	Squeeze priming bulb (p. 40).
Fuel filter or fuel tank filter restricted.	Replace restricted filters (p. 75 or 77).
Bad fuel; outboard motor stored without treating or draining gasoline, or refueled with bad gasoline.	Drain fuel tank and carburetor (p. 85). Refill with fresh gasoline (p. 71).
Spark plug faulty, fouled, or improperly gapped.	Adjust the spark plug electrode gap or replace spark plug (p. 70).
Spark plug wet with fuel (flooded engine).	Dry and reinstall spark plug. Start engine with choke and throttle open.
Carburetor malfunction, fuel pump failure, ignition malfunction, stuck valves, etc.	Take outboard motor to an authorized Marine dealer, or refer to the shop manual.

## TAKING CARE OF UNEXPECTED PROBLEMS

### HARD STARTING OR STALLS AFTER STARTING

Possible Cause	Correction
Choke OFF.	Pull choke knob to ON position, unless engine is warm (p. 44).
Throttle grip not in START position.	Turn throttle grip to START position (p. 44).
Fuel valve lever is not turned to the appropriate position.	Turn the fuel valve lever to the appropriate position (p. 19).
Fuel vent closed (internal fuel tank).	Turn the internal fuel tank vent knob counterclockwise to the open position (p. 21).
When using the portable fuel tank (BF5D and BF6A), fuel vent closed (portable fuel tank).	Turn the portable fuel tank vent knob counterclockwise to the open position (p. 26).
When using the portable fuel tank (BF5D and BF6A), fuel hose not primed.	Squeeze priming bulb (p. 40).
Fuel filter or fuel tank filter restricted.	Replace restricted filters (p. 75 or 77).
Bad fuel; outboard motor stored without treating or draining gasoline, or refueled with bad fuel.	Drain fuel tank and carburetor (p. 85). Refill with fresh gasoline (p. 71).

## TAKING CARE OF UNEXPECTED PROBLEMS

---

### HARD STARTING OR STALLS AFTER STARTING

Possible Cause	Correction
Spark plug faulty, fouled, or improperly gapped.	Adjust the spark plug electrode gap or replace spark plug (p. 70).
Carburetor malfunction, fuel pump failure, ignition malfunction, etc.	Take outboard motor to an authorized Marine dealer, or refer to the shop manual.

### ENGINE OVERHEATS

Possible Cause	Correction
Water intakes clogged.	Clean water intakes.
Faulty thermostat or water pump.	Take outboard motor to an authorized Marine dealer, or refer to the shop manual.

## TAKING CARE OF UNEXPECTED PROBLEMS

---

### ENGINE WILL NOT DRIVE THE PROPELLER

Possible Cause	Correction
Broken shear pin.	Replace shear pin (p. 79).
Damaged gearshift mechanism.	Take outboard motor to an authorized Marine dealer, or refer to the shop manual.

## TAKING CARE OF UNEXPECTED PROBLEMS

### BATTERY WILL NOT CHARGE (Equipped type)

The battery-charging circuit is protected by the 15-ampere fuse.

#### Fuse Replacement

1. Stop the engine.

2. Remove and inspect the fuse. If a fuse is burnt out, install a replacement fuse of the specified rating. The outboard motor is supplied with a spare fuse in fuse holder.

DESIGNATED FUSE RATING:  
15A

#### NOTICE

Never use a fuse with a rating greater than specified. Serious damage to the electrical system could result.

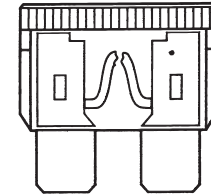
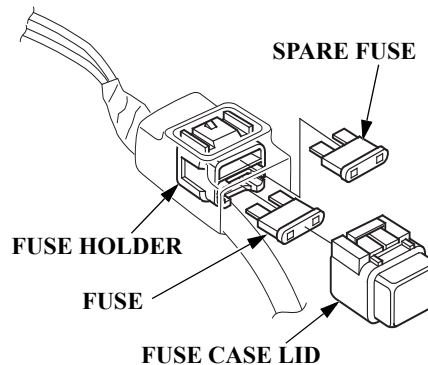

**BLOWN FUSE**

3. Reinstall the fuse case lid.

Before further operation, try to determine and correct the electrical problem that caused the fuse to burn out. An uncorrected electrical problem may cause the fuse to burn out again.

## TAKING CARE OF UNEXPECTED PROBLEMS

### OIL PRESSURE INDICATOR GOES OFF AND ENGINE SPEED IS LIMITED

OIL PRESSURE INDICATOR

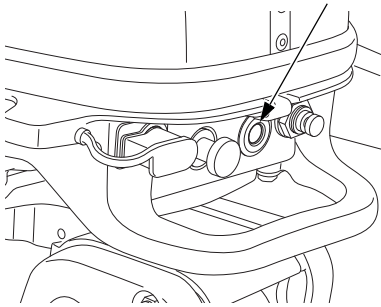

If oil pressure becomes low, the green indicator will go off. If you are at cruising speed, engine speed will decrease gradually.

Low oil pressure may be the result of a low engine oil level, or there may be a problem with the engine lubrication system.

If the throttle is closed suddenly after full throttle operation, engine speed may drop below the specified idle rpm, and that could activate the engine protection system momentarily.

If low oil pressure activates the engine protection system, stop the engine, check the engine oil level (p. 64), and add oil if needed.

With the engine oil at the recommended level, restart the engine. If the lubrication system is OK, the green indicator should come on within 30 seconds, and the engine will respond normally to throttle grip operation.

If the engine protection system remains activated after 30 seconds, return to the nearest boat landing, and have the outboard motor inspected by an authorized Marine dealer.

## TAKING CARE OF UNEXPECTED PROBLEMS

### SUBMERGED OUTBOARD MOTOR

A submerged outboard motor must be serviced immediately after it is recovered from the water in order to minimize corrosion.

If there is a Honda Marine dealership nearby, take the outboard motor to the dealer immediately. If you are far from a dealer, proceed as follows:

1. Unlock and remove the engine cover (p. 63), and rinse the outboard motor with fresh water to remove salt water, sand, mud, etc.
2. Drain the internal fuel tank and carburetor as described on p. 85.

3. Change the engine oil as described on p. 65. If there was water in the engine crankcase, or if the used engine oil showed signs of water contamination, then a second engine oil change should be performed after running the engine for half an hour.

STARTER GRIP

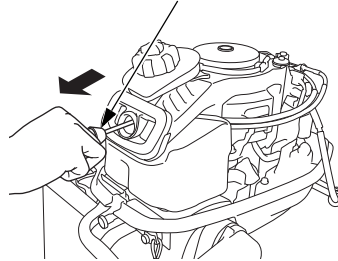

4. Remove the spark plug (p. 70), and remove the emergency stop switch clip from the emergency stop switch. Pull the starter grip, rotate the flywheel a few revolutions to completely expel any water from the cylinder.

If the engine was running when it submerged, there may be mechanical damage, such as a bent connecting rod. If the engine binds when cranked, do not attempt to run the engine until it has been repaired.

#### NOTICE

*When cranking the engine with an open ignition circuit (spark plug removed from the ignition circuit), remove the emergency stop switch clip from the emergency stop switch to prevent possible damage to the ignition system.*



## TAKING CARE OF UNEXPECTED PROBLEMS

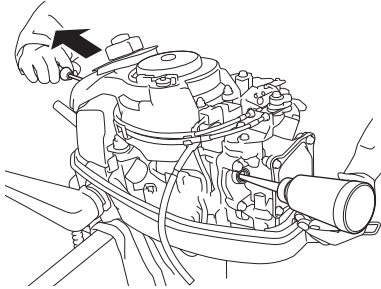

5. Pour a teaspoon (5 - 10 cm<sup>3</sup>) of engine oil into the spark plug hole, and then pull the starter grip several times to lubricate the inside of the cylinder.
6. Reinstall the spark plug, and put the emergency stop switch clip into the emergency stop switch.

7. Attempt to start the engine. Be sure the water level is at least 2 inches (5 cm) above the antivibration plate.

If the engine fails to start, remove the spark plug, clean and dry it, then reinstall the spark plug and attempt to start the engine again.

If the engine starts, and no mechanical damage is evident, continue to run the engine for a half hour or longer. Be sure the water level is at least 2 inches (5 cm) above the antivibration plate to avoid overheating and water pump damage.

8. As soon as possible, take the outboard motor to an authorized Marine dealer for inspection and service.

# TECHNICAL INFORMATION

## Serial Number Locations

Record the frame serial number, the engine serial number, and the date of purchase in the space provided on this page. You will need these numbers when ordering parts, and when making technical or warranty inquiries (p. 110).

**ENGINE SERIAL  
NUMBER**

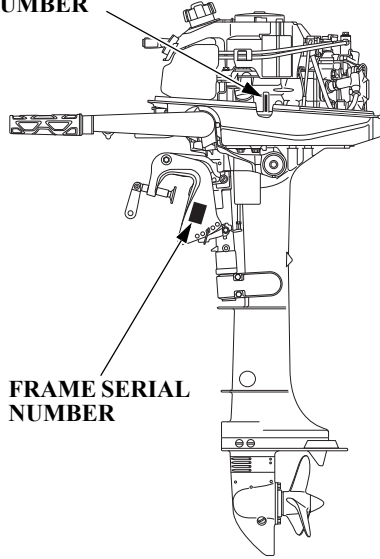

**FRAME SERIAL  
NUMBER**

The frame serial number is stamped on a plate attached on the left side of the stern bracket.

The engine serial number is located on the left side of the engine.

Frame serial number:

---

Date of purchase:

---

Engine serial number:

---

## Carburetor Modification for High Altitude Operation

At altitudes above 3,000 feet (900 meters), the standard carburetor air-fuel mixture will be too rich. Performance will decrease, and fuel consumption will increase. A very rich mixture will also foul the spark plug and cause hard starting. Operation at an altitude that differs from that at which this engine was certified, for extended periods of time, may increase emissions.

High altitude operation can be improved by specific modifications to the carburetor. If you usually operate your outboard motor at 3,000 feet (900 meters) or above, consult with your authorized Honda Marine dealer.

Your dealer can determine the appropriate carburetor settings for the altitude at which you operate your outboard motor.

Even with carburetor modification, engine horsepower will decrease about 3.5% for each 1,000-foot (300-meter) increase in altitude. The effect of altitude on horsepower will be greater than this if no carburetor modification is made.

### NOTICE

*When the carburetor has been modified for operation at one of the higher altitude ranges, the air-fuel mixture will be too lean for operation at a lower altitude.*

*Operation at altitudes below the range for which the carburetor is set may cause the engine to overheat and result in serious engine damage.*

*For use at lower altitudes, have an authorized Marine dealer modify the carburetor for the correct altitude range.*

## Battery (Equipped type)

For complete information, refer to the battery manufacturer's instructions.

## Minimum Requirements

12V-28Ah/5HR (CCA 265)

## TECHNICAL INFORMATION

---

### Emission Control System Information

#### *Source of Emissions*

The combustion process produces carbon monoxide, oxides of nitrogen, and hydrocarbons. Control of hydrocarbons and oxides of nitrogen is very important because, under certain conditions, they react to form photochemical smog when subjected to sunlight. Carbon monoxide does not react in the same way, but it is toxic.

Honda utilizes appropriate air/fuel ratios and other emissions control systems to reduce the emissions of carbon monoxide, oxides of nitrogen, and hydrocarbons.

#### *The U.S., California Clean Air Acts, and Canadian Environmental Protection Act*

EPA, California, and Canadian regulations require all manufacturers to furnish written instructions describing the operation and maintenance of emission control systems.

The following instructions and procedures must be followed in order to keep the emissions from your Honda engine within the emission standards.

#### *Tampering and Altering*

##### **NOTICE**

*Tampering is a violation of Federal and California law.*

Tampering with or altering the emission control system may increase emissions beyond the legal limit. Among those acts that constitute tampering are:

- Removal or alteration of any part of the intake, fuel, or exhaust systems.
- Alterations that would cause the engine to operate outside its design parameters.

### ***Problems That May Affect Emissions***

If you are aware of any of the following symptoms, have your engine inspected and repaired by your servicing dealer.

- Hard starting or stalling after starting.
- Rough idle.
- Misfiring or backfiring under load.
- Afterburning (backfiring).
- Black exhaust smoke or high fuel consumption.

### ***Replacement Parts***

The emission control systems on your Honda engine were designed, built, and certified to conform with EPA and California emission regulations. To ensure the best quality and reliability, use only new, Honda Genuine parts or their equivalents for repair and replacement. Maintenance, replacement, or repair of the emission control devices and systems may be performed by any marine engine repair establishment or individual, using parts that are “certified” to EPA standards.

A manufacturer of an aftermarket part assumes the responsibility that the part will not adversely affect emission performance. The manufacturer or rebuilder of the part must certify that use of the part will not result in a failure of the engine to comply with emission regulations.

### ***Maintenance***

Follow the maintenance schedule on (p. 61 and 62). Remember that this schedule is based on the assumption that your machine will be used for its designed purpose. Sustained high-load operation, or use in unusual conditions, will require more frequent service.

## TECHNICAL INFORMATION

---

### Star Label

US, Puerto Rico, and US Virgin Islands

A Star label was applied to this outboard motor in accordance with the requirements of the California Air Resources Board.

### *The Star Label means Cleaner Marine Engine*

This engine has been certified as a:

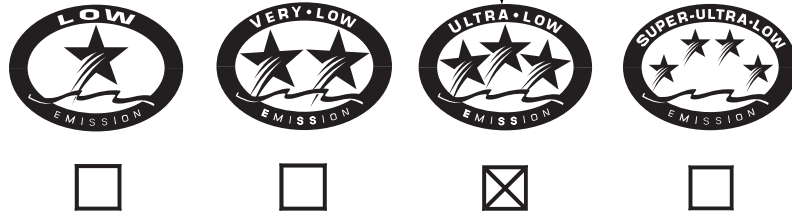

### **The Symbol for Cleaner Marine Engines:**

**Cleaner Air and Water** - for healthier lifestyle and environment.

**Better Fuel Economy** - burns up to 30 - 40 percent less gas and oil than conventional carbureted two-stroke engines, saving money and resources.

**Longer Emission Warranty** - protects consumer for worry-free operation.



### **One Star Low Emission**

The one-star label identifies engines that meet the Air Resources Board's Personal Watercraft and Outboard marine engine 2001 exhaust emission standards. Engines meeting these standards have 75% lower emissions than conventional carbureted two-stroke engines. These engines are equivalent to the U.S. EPA's 2006 standards for marine engines.



### **Two Stars Very Low Emission**

The two-star label identifies engines that meet the Air Resources Board's Personal Watercraft and Outboard marine engine 2004 exhaust emission standards. Engines meeting these standards have 20% lower emissions than One Star-Low Emission engines.



### **Three Stars Ultra Low Emission**

The three-star label identifies engines that meet the Air Resources Board's Personal Watercraft and Outboard marine engine 2008 exhaust emission standards or the Sterndrive and Inboard marine engine 2003-2008 exhaust emission standards. Engines meeting these standards have 65% lower emissions than One Star-Low Emission engines.



### **Four Stars Super Ultra Low Emission**

The four-star label identifies engines that meet the Air Resources Board's Sterndrive and Inboard marine engine 2009 exhaust emission standards. Personal Watercraft and Outboard marine engines may also comply with these standards. Engines meeting these standards have 90% lower emissions than One Star-Low Emission engines.

Cleaner Watercraft - Get the Facts  
1-800-END-SMOG  
[www.arb.ca.gov](http://www.arb.ca.gov)

# TECHNICAL INFORMATION

## Specifications

MODEL	BF4AH			
Description code	BACC			
Type	SHNA	LHNA	SHNC	LHNC
Overall length	20.6 in (524 mm)			
Overall width	13.7 in (347 mm)			
Overall height	40.7 in (1,033 mm)	45.7 in (1,160 mm)	40.7 in (1,033 mm)	45.7 in (1,160 mm)
Transom height (when transom angle at 14°)	17.1 in (434 mm)	22.1 in (561 mm)	17.1 in (434 mm)	22.1 in (561 mm)
Dry mass [weight] *1	59.5 lbs (27.0 kg)	60.6 lbs (27.5 kg)	59.5 lbs (27.0 kg)	60.6 lbs (27.5 kg)
Rated power	3.0 kW (4 HP)			
Full throttle range	4,500 – 5,500 rpm			
Engine type	4 stroke OHV 1 cylinder, water-cooled			
Displacement	7.7 cu-in (127 cm <sup>3</sup> )			
Spark plug gap	0.024 - 0.028 in (0.6 - 0.7 mm)			
Starter system	Recoil starter			
Ignition system	C.D.I.			
Lubrication system	Trochoid pump pressure lubrication			
Specified oil	Engine: API standard (SG, SH or SJ oil) SAE 10W-30 Gear case: API standard (GL-4) SAE 75W-90 or 90 Hypoid gear oil			
Oil capacity	Engine: 18 US oz (0.55 L, 0.48 Imp qt) Gear case: 3 US oz (0.10 L, 0.09 Imp qt)			
CARB star label	ULTRA LOW EMISSION			
Cooling system	Water cooling with thermostat			

Exhaust system	Underwater exhaust
D.C. output *2	12V - 6A
Spark plug	BKR6E-E (NGK)
Fuel pump	Mechanical type fuel pump
Fuel	Unleaded gasoline (86 pump octane or higher)
Tank capacity	0.40 US gal (1.5 L, 0.33 Imp gal)
Gear change	Forward-Neutral-Reverse (dog type)
Steering angle	45° right and left
Transom angle	5 stages (4°, 8°, 12°, 16°, 20°)
Tilt up angle (when transom angle at 12°)	3 stages adjustment (18°, 34° and 58°)
Standard propeller (No. of blades – diameter × pitch)	3 – 200 × 150 mm (3 – 7-7/8 × 5-7/8 in)

## Tuneup

Spark plug gap	0.024 - 0.028 in (0.6 - 0.7 mm)	See page 70
Idle speed	1,550 ± 100 rpm	See shop manual
Valve clearance (cold)	Intake: 0.10 ± 0.04 mm Exhaust: 0.15 ± 0.04 mm	See shop manual
Other specifications	No other adjustment is needed	

\*1 Without charge coil, with propeller

\*2 Optional Equipment

Honda outboard motors are power rated in accordance with NMMA procedures and using the ICOMIA standard 28/23.



## Specifications

MODEL	BF5DH					
Description code	BADC					
Type	SHNA	LHNA	SHNC	LHNC	SHC	LHC
Overall length	20.6 in (524 mm)					
Overall width	13.7 in (347 mm)					
Overall height	40.7 in (1,033 mm)	45.7 in (1,160 mm)	40.7 in (1,033 mm)	45.7 in (1,160 mm)	40.7 in (1,033 mm)	45.7 in (1,160 mm)
Transom height (when transom angle at 14°)	17.1 in (434 mm)	22.1 in (561 mm)	17.1 in (434 mm)	22.1 in (561 mm)	17.1 in (434 mm)	22.1 in (561 mm)
Dry mass [weight]	59.5 lbs* <sup>1</sup> (27.0 kg)	60.6 lbs* <sup>1</sup> (27.5 kg)	59.5 lbs* <sup>1</sup> (27.0 kg)	60.6 lbs* <sup>1</sup> (27.5 kg)	61.3 lbs* <sup>2</sup> (27.8 kg)	62.4 lbs* <sup>2</sup> (28.3 kg)
Rated power	3.7 kW (5 HP)					
Full throttle range	4,500 – 5,500 rpm					
Engine type	4 stroke OHV 1 cylinder, water-cooled					
Displacement	7.7 cu-in (127 cm <sup>3</sup> )					
Spark plug gap	0.024 - 0.028 in (0.6 - 0.7 mm)					
Starter system	Recoil starter					
Ignition system	C.D.I.					
Lubrication system	Trochoid pump pressure lubrication					
Specified oil	Engine: API standard (SG, SH or SJ oil) SAE 10W-30 Gear case: API standard (GL-4) SAE 75W-90 or 90 Hypoid gear oil					
Oil capacity	Engine: 18 US oz (0.55 L, 0.48 Imp qt) Gear case: 3 US oz (0.10 L, 0.09 Imp qt)					
CARB star label	ULTRA LOW EMISSION					
Cooling system	Water cooling with thermostat					

Exhaust system	Underwater exhaust
D.C. output * <sup>3</sup>	12V - 6A
Spark plug	BKR6E-E (NGK)
Fuel pump	Mechanical type fuel pump
Fuel	Unleaded gasoline (86 pump octane or higher)
Tank capacity	<b>Internal fuel tank:</b> 0.40 US gal (1.5 L, 0.33 Imp gal) <b>Portable fuel tank:</b> 3.2 US gal (12 L, 2.6 Imp gal)
Gear change	Forward-Neutral-Reverse (dog type)
Steering angle	45° right and left
Transom angle	5 stages (4°, 8°, 12°, 16°, 20°)
Tilt up angle (when transom angle at 12°)	3 stages adjustment (18°, 34° and 58°)
Standard propeller (No. of blades – diameter × pitch)	3 – 200 × 170 mm (3 – 7-7/8 × 6-3/4 in)

## Tuneup

Spark plug gap	0.024 - 0.028 in (0.6 - 0.7 mm)	See page 70
Idle speed	1,550 ± 100 rpm	See shop manual
Valve clearance (cold)	Intake: 0.10 ± 0.04 mm Exhaust: 0.15 ± 0.04 mm	See shop manual
Other specifications	No other adjustment is needed	

\*1 Without charge coil, with propeller

\*2 With charge coil and propeller

\*3 SHNA, LHNA, SHNC and LHNC types are Optional Equipment

Honda outboard motors are power rated in accordance with NMMA procedures and using the ICOMIA standard 28/23.

# TECHNICAL INFORMATION

## Specifications

MODEL	BF6AH			
Description code	BAEC			
Type	SHNA	LHNA	SHC	LHC
Overall length	20.6 in (524 mm)			
Overall width	13.7 in (347 mm)			
Overall height	40.7 in (1,033 mm)	45.7 in (1,160 mm)	40.7 in (1,033 mm)	45.7 in (1,160 mm)
Transom height (when transom angle at 14°)	17.1 in (434 mm)	22.1 in (561 mm)	17.1 in (434 mm)	22.1 in (561 mm)
Dry mass [weight]	59.5 lbs <sup>*1</sup> (27.0 kg)	60.6 lbs <sup>*1</sup> (27.5 kg)	61.3 lbs <sup>*2</sup> (27.8 kg)	62.4 lbs <sup>*2</sup> (28.3 kg)
Rated power	4.5 kW (6 HP)			
Full throttle range	5,000 – 6,000 rpm			
Engine type	4 stroke OHV 1 cylinder, water-cooled			
Displacement	7.7 cu-in (127 cm <sup>3</sup> )			
Spark plug gap	0.024 - 0.028 in (0.6 - 0.7 mm)			
Starter system	Recoil starter			
Ignition system	C.D.I.			
Lubrication system	Trochoid pump pressure lubrication			
Specified oil	Engine: API standard (SG, SH or SJ oil) SAE 10W-30 Gear case: API standard (GL-4) SAE 75W-90 or 90 Hypoid gear oil			
Oil capacity	Engine: 18 US oz (0.55 L, 0.48 Imp qt) Gear case: 3 US oz (0.10 L, 0.09 Imp qt)			
CARB star label	ULTRA LOW EMISSION			
Cooling system	Water cooling with thermostat			

\*1 Without charge coil, with propeller

\*2 With charge coil and propeller

\*3 SHNA and LHNA types are Optional Equipment

Exhaust system	Underwater exhaust
D.C. output <sup>*3</sup>	12V - 6A
Spark plug	BKR6E-E (NGK)
Fuel pump	Mechanical type fuel pump
Fuel	Unleaded gasoline (86 pump octane or higher)
Tank capacity	<b>Internal fuel tank:</b> 0.40 US gal (1.5 L, 0.33 Imp gal) <b>Portable fuel tank:</b> 3.2 US gal (12 L, 2.6 Imp gal)
Gear change	Forward-Neutral-Reverse (dog type)
Steering angle	45° right and left
Transom angle	5 stages (4°,8°,12°,16°,20°)
Tilt up angle (when transom angle at 12°)	3 stages adjustment (18°, 34° and 58°)
Standard propeller (No. of blades - diameter × pitch)	3 - 200 × 150 mm (3 - 7-7/8 × 5-7/8 in)

## Tuneup

Spark plug gap	0.024 - 0.028 in (0.6 - 0.7 mm)	See page 70
Idle speed	1,550 ± 100 rpm	See shop manual
Valve clearance (cold)	Intake: 0.10 ± 0.04 mm Exhaust: 0.15 ± 0.04 mm	See shop manual
Other specifications	No other adjustment is needed	

Honda outboard motors are power rated in accordance with NMMA procedures and using the ICOMIA standard 28/23.

### **Dealer Locator Information**

To find an authorized Honda  
Servicing Dealer

For USA:

Visit our website:

<http://marine.honda.com> and click on  
Find a Dealer

For Canada:

Call 1-888-946-6329 or visit our  
website:

English

<http://marine.honda.ca/dealerlocator>

French

[http://marine.honda.ca/  
trouver-concessionnaire](http://marine.honda.ca/trouver-concessionnaire)

### **Honda Publications**

These publications will give you  
additional information for  
maintaining and repairing your  
outboard motor.

### ***Shop Manual***

This manual covers complete  
maintenance and overhaul procedures.  
It is intended to be used by a skilled  
technician.

For USA:

Shop manuals are available through  
your Honda Marine dealer or visit  
[http://marine.honda.com /Service &  
Support](http://marine.honda.com/Service%20&%20Support) and click on Shop Manuals

For Canada:

Contact your dealer for information  
on the Shop Manual.

### ***Parts Catalog***

For USA:

This manual provides complete,  
illustrated parts lists.  
The catalog is available through your  
Honda Marine dealer or visit  
[http://marine.honda.com/Parts &  
Accessories](http://marine.honda.com/Parts%20&%20Accessories) and click on Look Up  
Parts

For Canada:

Contact your dealer for information  
on Parts.

### ***Accessory Catalog***

Your authorized Honda Marine dealer  
offers a wide selection of accessories  
(optional equipment, oils, and  
lubricants) to enhance your boating  
experience.

For USA:

Visit <http://marine.honda.com> and  
click on PARTS & ACCESSORIES  
to see the entire catalog of  
accessories.

For Canada:

Check with your dealer or visit  
[www.honda.ca](http://www.honda.ca) and select the Parts  
and Accessories tab under the Honda  
Marine segment to view the range of  
accessories available.

## CONSUMER INFORMATION

---

### Customer Service Information

#### *Contacting Honda*

Your Owner's Manual was written to cover most of the questions you might ask about your Honda. Any questions not answered in the Owner's Manual can be answered by your Honda dealer. If your dealer doesn't have an immediate answer, they should be able to get it for you.

If you have a difference of opinion with your dealer, please remember that each dealership is independently owned and operated. That's why it's important to work to resolve any differences at the dealership level. If the service personnel are unable to assist you, please discuss your concerns with the dealer management such as the Service Manager or the dealership's owner.

If you need to contact Honda regarding your experiences with your Honda product or with your dealer, please contact the Honda office in your region:

#### **American Honda Motor Co., Inc.**

Marine Division  
Customer Relations Office  
4900 Marconi Drive  
Alpharetta, GA 30005-8847  
Telephone (770) 497 – 6400  
M-F 9:00 am-7:30 pm (Eastern Time Zone)

In Canada:

#### **Honda Canada Inc.**

Customer Relations Department  
180 Honda Boulevard  
Markham, Ontario L6C 0H9  
Tel: 1-888-946-6329 (Toll free)  
Fax: 1-877-939-0909 (Toll free)

Please include the following information in your communication:

- Your name, address and telephone number (complete with area code)
- Model and complete serial number
- Date of purchase
- Name and location of selling dealer
- Name and location of servicing dealer (if different)
- A detailed description of your concerns

We will likely ask your Honda dealer to respond, or possibly acknowledge your comments directly.

#### ***Warranty Coverage***

Your new Honda is covered by the following warranties:

- Distributor's Limited Warranty
- Emission Control System Warranty

Please read the warranty statements contained in this manual. There are responsibilities, restrictions, and exclusions that apply to these warranties.

To obtain warranty service you must take your Honda outboard motor, together with proof of original retail purchase date, at your expense, to a Honda engine dealer or distributor authorized to sell that product in the United States, Puerto Rico, the U.S. Virgin Islands or Canada.

It is important to realize that your warranty applies to defects in material or workmanship of your Honda. Your warranty coverage does not apply to normal wear or deterioration associated with using your Honda outboard motor.

Your warranty coverage will not be voided if you choose to perform your own maintenance. However, you should have the proper tools and service information and be mechanically qualified. Failures that occur due to modifications, improper maintenance, or service are not covered.

### *Warranty Service*

Please remember that recommended maintenance interval servicing is not included in your warranty coverage. Additionally, your warranty does not apply to the normal wear of items (such as spark plug(s), water pump, etc.).

As the owner of a Honda product, your servicing dealer may ask you to authorize an inspection. If the problem is covered under warranty, your dealer will perform any warranty repairs for you at no cost. However, you may be responsible for additional non-warranty charges.

If you have questions about warranty coverage or the nature of the repair, it is best to talk to the service manager of your Honda dealer.

Sometimes, in spite of the best intentions of all concerned, a misunderstanding may occur. If you aren't satisfied with your dealer's handling of the situation, we suggest you discuss your problem with the appropriate member of the dealership's management team. If the problem has already been reviewed with the appropriate manager of the Service, Parts, or Sales department, contact the owner of the dealership or their designated representative.

# CONSUMER INFORMATION

## Warranty Statements

The American Honda Distributor's Limited Warranty applies to outboards purchased in the United States, Puerto Rico, or the U.S. Virgin Islands. The Honda Canada Distributor's Warranty applies to outboards purchased in Canada. The product warranty is only valid in the country where the product was purchased.

## United States, Puerto Rico and U.S. Virgin Islands

### Distributor's Limited Warranty

This warranty is limited to Honda Outboard Motors and related original equipment distributed by American Honda Motor Co., Inc., Power Equipment Division, 4900 Marconi Drive, Alpharetta, Georgia 30005-8847.

Products Covered by Warranty:	Length of Warranty: (from date of original retail purchase)		
	NON-COMMERCIAL/ NON-RENTAL	COMMERCIAL/RENTAL	STATE/LOCAL/FEDERAL GOVERNMENT
All models purchased on or after Jan. 1, 2016 <sup>(2)</sup>	60 months	24 months	36 months
All models purchased between July 1, 2008 and December 31, 2015 <sup>(2)</sup>	60 months	12 months	24 months
All models purchased on or before June 30, 2008 <sup>(1) (2)</sup>	36 months	12 months	24 months
Related original equipment items: BF5 through BF20 models: Portable fuel tank and original propeller. All models: Primer bulb/fuel line assembly and tiller handle.	The same duration as the outboard with which they were purchased. <sup>(3)</sup>		

(1) Models purchased prior to July 1, 2008 (unless previously purchased with True-5 warranty from a participating dealer).

(2) 40, 65, & 105 Jet models: Jet pump assembly is a dealer installed option. Jet pump warranty is provided by Specialty Manufacturing Co. (Outboard Jets).

(3) Portable fuel tanks: 24 months or the same duration as the outboard they were purchased with, whichever is longer.

### **To Qualify for This Warranty:**

The Honda Outboard Motor must be purchased from American Honda or a dealer authorized by American Honda to sell Honda Outboard Motors in the United States, Puerto Rico, or the U.S. Virgin Islands. This limited warranty applies to the first retail purchaser and each subsequent owner during the applicable warranty time period.

### **What American Honda Will Repair or Replace Under Warranty:**

American Honda will repair or replace, at its option, any part that is proven to be defective in material or workmanship under normal use during the applicable warranty time period. Warranty repairs and replacements will be made without charge for parts or labor. Anything replaced under warranty becomes the property of American Honda Motor Company, Inc.

All parts replaced under warranty will be considered as part of the original product and any warranty on those parts will expire coincidentally with the original product warranty.

### **To Obtain Warranty Service:**

You must, at your expense, take your Honda Outboard Motor and proof of the original purchase date to any dealer who is authorized to service Honda Outboard Motors in the United States, Puerto Rico, or the U.S. Virgin Islands, during the dealer's normal business hours. If you are unable to obtain warranty service, or are dissatisfied with the warranty service you receive, take the following steps: First, contact the owner of the dealership involved; normally this should resolve the problem. However, if you should require further assistance, write or call the Honda Marine Customer Relations Department of American Honda Motor Co., Inc. Please see *Contacting Honda* page 110.

## CONSUMER INFORMATION

---

### **Exclusions:**

This warranty does not extend to the following:

- Conditions caused by lack of routine maintenance or improper storage (as outlined in the Owner's Manual)
- Conditions caused by the use of propeller (s) that do not allow the outboard motor to run in its recommended full throttle rpm range
- Operation inconsistent with the recommended operation/duty cycle (as outlined in the Owner's Manual)
- Parts affected or damaged by an abuse, submersion and/or collision
- Normal wear and tear
- Fuel contamination and water entering the engine through the fuel intake, air intake or exhaust system
- Operation with fuels, oils, additives and lubricants which are not suitable for use in the product
- Use in an application for which the outboard motor was not designed, such as racing or competitive use or any other misuse or neglect
- Incorporation of unsuitable attachments or parts
- The unauthorized alteration, improper installation and/or rigging, or any causes other than defects in material or workmanship
- Corrosion to steering system or electrical components, corrosion due to electrolysis, water born foreign chemicals, improper service or corrosion caused by damage or abuse

- Reimbursement for towing charges, in and out of water charges, or technician travel time
- Growth of marine organisms on motor surfaces, external or internal
- Any product that has ever been declared a total loss or sold for salvage by a financial institution or insurer, or that has been issued a "salvage" or similar title under any states law.

### **Disclaimer of consequential damage and limitation of implied warranties:**

American Honda disclaims any responsibility for loss of time or use of the outboard, revenue, or the equipment in which the outboard is installed, transportation, commercial loss, or any other incidental or consequential damage. Any implied warranties are limited to the duration of this written limited warranty.

Some states do not allow limitations on how long an implied warranty lasts and/or do not allow the exclusion or limitation of incidental or consequential damages, so the above exclusions and limitations may not apply to you. This warranty gives you specific legal rights, and you may also have other rights which vary from state to state.



# CONSUMER INFORMATION

**Accessories and Replacement Parts**

This warranty is limited to Honda Marine parts, accessories and apparel when distributed by American Honda Motor Co., Inc., 1919 Torrance Blvd., Torrance, California 90501-2746.

Products Covered by Warranty:	Length of Warranty: (from date of original retail purchase)		
	NON-COMMERCIAL	COMMERCIAL/RENTAL	STATE/LOCAL/FEDERAL GOVERNMENT
Accessories other than noted below	12 months	3 months	3 months
Emission related accessories: Portable fuel tanks, fuel line assemblies, and water/fuel separators	24 months	24 months	24 months
Replacement Parts	6 months	3 months	3 months

**To Qualify for This Warranty:**

1. The accessories or replacement parts must be purchased from American Honda or a dealer, distributor, or distributor’s dealer authorized by American Honda to sell those products in the United States, Puerto Rico, and the U.S. Virgin Islands. Parts and Accessories must be purchased for installation on original Honda equipment or engines to be eligible for warranty coverage. Installing parts and accessories on non-Honda products or engines voids this warranty.
2. You must be the first retail purchaser. This warranty is not transferable to subsequent owners.

**What American Honda Will Repair or Replace Under Warranty:**

American Honda will repair or replace, at its option, any

marine product accessories or replacement parts that are proven to be defective in material or workmanship under normal use during the applicable warranty time period. Anything replaced under warranty becomes the property of American Honda Motor Company, Inc. All parts replaced under warranty will be considered as part of the original product and any warranty on those parts will expire coincidentally with the original product warranty.

Accessories and replacement parts, installed by a dealer who is authorized by American Honda to sell them, will be repaired or replaced under warranty without charge for parts or labor. If installed by anyone else, accessories and replacement parts will be repaired or replaced under warranty without charge for parts, but any labor charges will be the responsibility of the purchaser.

## CONSUMER INFORMATION

---

### **To Obtain Warranty Service:**

You must, at your expense, take the Honda Outboard Motor product accessory or replacement part or the outboard motor or boat on which the accessory or replacement part is installed, and proof of purchase to any Honda Marine authorized service facility or dealer in the United States, Puerto Rico, or the U.S. Virgin Islands, during normal business hours.

### **Exclusions:**

This warranty does not extend to accessories or parts affected or damaged by collision, normal wear, use in an application for which the product was not designed or any other misuse, neglect, incorporation or use of unsuitable attachments or parts, unauthorized alteration, improper installation, or any causes other than defects in material or workmanship of the product.

Installing parts and accessories on non-Honda products or engines voids this warranty.

### **Disclaimer of consequential damage and limitation of implied warranties:**

American Honda disclaims any responsibility for loss of time or use of the outboard motor, or the boat on which the product is installed, transportation, commercial loss, or any other incidental or consequential damage. Any implied warranties are limited to the duration of this

written warranty. Some states do not allow limitations on how long an implied warranty lasts and/or do not allow the exclusion or limitation of incidental or consequential damages, so the above exclusions and limitations may not apply to you. This warranty gives you specific legal rights, and you may also have other rights, which vary from state to state.

### **Emission Control System Warranty**

Your new Honda outboard engine complies with both the U.S. EPA and State of California emission regulations. American Honda provides the same emission warranty coverage for outboard engines sold in all 50 states. In all areas of the United States your outboard engine must be designed, built, and equipped to meet the U.S. EPA and California Air Resources Board emission standard for spark ignited marine engines.

### **CALIFORNIA EMISSIONS CONTROL SYSTEM WARRANTY STATEMENT YOUR WARRANTY RIGHTS AND OBLIGATIONS**

The California Air Resources Board (CARB) and American Honda Motor Co., Inc. are pleased to explain the emission control system warranty on your 2021 Honda outboard engine. In California, new outboard engines must be designed, built, and equipped to meet the state's stringent anti-smog standards.

American Honda Motor Co., Inc. must warrant the emission control system on your outboard engine for the periods of time listed below provided there has been no abuse, neglect, or improper maintenance of your outboard engine.

Your emission control system may include parts such as the carburetor or fuel injection system, the ignition system, catalytic converter, canisters, clamps, filters, fuel caps, fuel lines, fuel tanks, valves, and vapor hoses. Also included may be hoses, belts, connectors, and other emission-related assemblies.

Where a warrantable condition exists, American Honda Motor Co., Inc. will repair your outboard engine at no cost to you including diagnosis, parts, and labor.

## CONSUMER INFORMATION

---

### MANUFACTURER'S WARRANTY COVERAGE:

Select emission control parts from model year 2010 and later outboard engines are warranted for five years or 250 hours of use, whichever first occurs; or the length of the *Honda Marine Distributor's Limited Warranty*, whichever is longer. The evaporative emission control system from model year 2010 and later outboard engines are warranted for two years with no limit on hours of use, or the length of the *Honda Marine Distributor's Limited Warranty*, whichever is longer, from the date of delivery to the retail purchaser. However, warranty coverage based on the hourly period is only permitted for engines equipped with hour meters as defined in § 2441(a)(13)\* or their equivalent. If any emission-related part on your engine is defective under warranty, the part will be repaired or replaced by American Honda Motor Co., Inc. See the *Emission Control System Warranty Parts* table on page 121 for parts description.

\* California Code of Regulations.

### OWNER'S WARRANTY RESPONSIBILITIES:

As the outboard engine owner, you are responsible for the performance of the required maintenance listed in your owner's manual. American Honda Motor Co., Inc. recommends that you retain all receipts covering maintenance on your outboard engine, but American Honda Motor Co., Inc. cannot deny warranty solely for the lack of receipts or your failure to ensure the performance of all scheduled maintenance.

As the outboard engine owner, you should, however, be aware that American Honda Motor Co., Inc. may deny you warranty coverage if your outboard engine or a part has failed due to abuse, neglect, improper maintenance, or unapproved modifications.

You are responsible for presenting your outboard engine to a Honda Marine dealer as soon as a problem exists. The warranty repairs will be completed in a reasonable amount of time, not to exceed 30 days.

If you have any questions regarding your warranty rights and responsibilities, you should contact

American Honda Motor Co., Inc.  
Marine Division Customer Relations Office  
4900 Marconi Drive  
Alpharetta, Georgia 30005-8847  
Telephone: (770) 497-6400

### WARRANTY COVERAGE:

See *Manufacturer's Warranty Coverage* above for warranty coverage terms. This warranty is transferred to each subsequent purchaser for the duration of the warranty period.

Warranty repairs will be made without charge for diagnosis, parts, and labor. All defective parts replaced under this warranty become the property of American Honda Motor Co., Inc. A list of warranty parts is on page 121. Normal maintenance items, such as spark plugs and filters, that are on the warranted parts list are warranted up to their required replacement interval only.

American Honda Motor Co., Inc. is also liable for damages to other engine components caused by a failure of any warranted part during the warranty period.

Only Honda approved replacement parts will be used in the performance of any warranty repairs, and they will be provided without charge to the owner. You may use any replacement part as defined in § 1900(b)(20)\* in the performance of any maintenance or repairs. Honda cannot deny coverage under the emission warranty solely for use of non-Honda replacement parts or service performed at a location other than an authorized Honda dealership; however, use of a part that is not functionally identical to the original equipment part in any respect that may in any way affect emissions (including durability) could result in denial of coverage. If a non-Honda replacement part is used in the repair or maintenance of your engine, and an authorized Honda Marine dealer determines it causes the failure of a warranted part, your warranty claim may be denied. If the part in question is not related to the reason that your engine requires repair, your claim will not be denied.

\* California Code of Regulations

## CONSUMER INFORMATION

---

### **TO OBTAIN WARRANTY SERVICE:**

You must take your Honda outboard engine, along with your sales registration card or other proof of original purchase date, at your expense, to any Honda Marine dealer that is authorized by American Honda Motor Co., Inc. to sell and service that Honda marine product during its normal business hours. Claims for repair or adjustment found to be caused solely by defects in material or workmanship will not be denied because the engine was not properly maintained and used.

If you are unable to obtain warranty service, or are dissatisfied with the warranty service you received, contact the owner of the dealership involved.

Normally this should resolve your problem. However, if you require further assistance, write or call the Honda Marine Customer Relations Office of American Honda Motor Co., Inc.

### **EXCLUSIONS:**

Failures other than those resulting from defects in material or workmanship are not covered by this warranty. This warranty does not extend to emission control systems or parts which are affected or damaged by owner abuse, neglect, improper maintenance, misuse, misfueling, improper storage, and/or collision, the incorporation of, or use of, unsuitable attachments, or the unauthorized alteration of any part. This warranty does not cover replacement of expendable maintenance items made in connection with required maintenance service after the items first scheduled replacement as listed in the maintenance section of the product owner's manual, such as: spark plugs and filters.

### **DISCLAIMER OF CONSEQUENTIAL DAMAGE AND LIMITATION OF IMPLIED WARRANTIES:**

American Honda Motor Co., Inc. disclaims any responsibility for incidental or consequential damages such as loss of time or the use of outboard engine, or any commercial loss due to the failure of the equipment; and any implied warranties are limited to the duration of this written warranty. This warranty is applicable only where the California or U.S. EPA emission control system warranty regulation is in effect.

## CONSUMER INFORMATION

### EMISSION CONTROL SYSTEM WARRANTY PARTS:

SYSTEMS COVERED BY THIS WARRANTY:	PARTS DESCRIPTION:	LENGTH OF WARRANTY:
Evaporative	Portable fuel tank, Outboard internal fuel tank, Fuel cap, Fuel hoses, Primer bulb, Fuel hose joint, Vapor separator, and Carbon canister, All other parts not listed that may affect the evaporative emissions control system	Two years, no limit on hours of use; or the length of the <i>Honda Distributor's Limited Warranty</i> , whichever is longer.
Fuel Metering	Carburetor assembly, Throttle body, Fuel injector, Fuel pump, Fuel pressure regulator, Throttle position sensor, Intake air temperature sensor, Engine temperature sensor, Manifold absolute pressure sensor, Idle air control valve, Barometric pressure sensor, Fuel line solenoid valve, Intake manifold, Intake valves, and Oxygen sensor or Air fuel ratio sensor	Five years or 250 hours of use, whichever first occurs; or the length of the <i>Honda Distributor's Limited Warranty</i> , whichever is longer.
Air Induction	Air intake duct, Intake manifold tuning valve (Intake air bypass control valve)	
Ignition	Flywheel magneto, Ignition pulse generator, Ignition coil assembly, Ignition control module, Engine control module, Crankshaft position sensor, Spark plug cap, Spark plug*, Knock sensor, and Camshaft position sensor	
Lubrication System	Oil pump and internal parts	
Crankcase Emission Control	Crankcase breather tube, Positive crankcase ventilation valve, Oil filler cap	
Exhaust	Exhaust manifold and Exhaust valves	
Valve Control System	Rocker arm oil control valve	
Miscellaneous Parts	Tubing, fittings, seals, gaskets, and clamps associated with these listed systems.	
* Covered up to the first required replacement only. See the <i>Maintenance Schedule</i> on page 61 and 62.		

# CONSUMER INFORMATION

## Canada

### Distributor's Warranty

HONDA CANADA INC., for and on behalf of Honda Motor Co. Ltd., Tokyo, Japan, gives the following written warranty on each new marine product manufactured by Honda Motor Co. Ltd., Japan, distributed in Canada by Honda Canada Inc. and sold by authorized Honda Marine dealers.

Whenever used herein, the word "Honda" refers to Honda Canada Inc. and/or Honda Motor Co. Ltd., as appropriate from the context.

HONDA WARRANTS THAT each new Honda marine product will be free, under normal use and maintenance, from any defects in material or workmanship for the relevant warranty period set forth below. If any defects should be found in a Honda marine product within the relevant warranty period, necessary repairs and replacements with a new part or the Honda equivalent shall be made at no cost to the consumer for parts and labour, when Honda acknowledges that such defects are attributable to faulty material or workmanship at the time of manufacture.

### WARRANTY PERIOD RETAILED ON OR AFTER APRIL 1, 2005:

	Non-commercial use	Commercial use
All Honda Outboard Models	36 Months	12 Months

### THIS WARRANTY COVERS

- a) Any Honda marine product purchased in Canada from an authorized Honda dealer which has been registered at the time of purchase on a form provided by Honda, which has had set-up and pre-delivery service performed by an authorized Honda dealer and which is normally operated in Canada;
- b) Any factory installed part (except normal maintenance parts referred to in "THIS WARRANTY DOES NOT COVER"); and
- c) Any marine product on which required maintenance services have been performed as prescribed in the Owner's Manual.



### THIS WARRANTY DOES NOT COVER

- a) Any repairs required as a result of collision, accident, striking any object, misuse or lack of required maintenance;
- b) Any repairs required as a result of any attachments, parts or devices installed by or repairs done by a party other than an authorized Honda dealer;
- c) Any outboard that has been operated out of water, (Run Dry) damaging the water pump and or engine components due to insufficient cooling water.
- d) Any marine products modified, altered, disassembled or remodelled;
- e) Normal maintenance services, including tightening of nuts, bolts and fittings and engine tune-up and the replacement of parts made in connection with normal maintenance services including filters, spark plugs and wires, fuses, belts, lubricants and other expendables susceptible to natural wear;
- f) Outboard propeller or shear pin.
- g) All accessories or attachments.

### THE OWNER'S OBLIGATION

In order to maintain the validity of this DISTRIBUTORS WARRANTY, the required maintenance services as set forth in the Owner's Manual must be performed at the proper intervals and detailed receipts and records retained as proof.

### TO OBTAIN WARRANTY SERVICE

You must take your Honda marine product, at your expense, during normal service hours, to any authorized Honda Marine dealership. If you are unable to obtain or are dissatisfied with the warranty service you receive, first contact the owner of the dealership involved; this should resolve the problem. If you require further assistance, contact Honda Canada's Customer Relations Department at:

HONDA CANADA INC.  
Customer Relations Department  
180 Honda Boulevard  
Markham, Ontario L6C 0H9  
Tel: 1-888-946-6329 (Toll free)  
Fax: 1-877-939-0909 (Toll free)  
E-mai: honda\_cr@ch.honda.com

## CONSUMER INFORMATION

---

### REPLACEMENT PARTS AND ACCESSORY WARRANTY

New genuine Honda replacement parts or accessories sold to a consumer or installed by an authorized Honda Marine dealer which are not covered by the DISTRIBUTORS WARRANTY are warranted for a period of one year from date of purchase, provided, however, that this Replacement Parts and Accessory Warranty does not apply to any replacement parts modified, used with, or installed on a marine product for which the replacement parts were not intended. Electrical components that are not installed by the dealer (sold over the counter) are not covered by warranty.

### ENTIRE WRITTEN WARRANTY

This DISTRIBUTORS WARRANTY and the REPLACEMENT PARTS AND ACCESSORY WARRANTY are the only and the entire written warranties given by Honda for Marine engines. No dealer or his agent or employee is authorized to extend or enlarge on these warranties on behalf of Honda by any written or verbal statement or advertisement.

### DISCLAIMER

To the extent the law permits, Honda disclaims any responsibility for loss of time or use of the product, transportation or towing costs or any other indirect, incidental or consequential damage, inconvenience or commercial loss.

### NOTICE TO CONSUMER

The provisions contained in these written warranties are not intended to limit, modify, take away from, disclaim or exclude any warranties set forth in or the operation of The Consumer Products Warranties Act, 1977 (Saskatchewan), The Consumer Product Warranty and Liability Act (New Brunswick), The Consumer Protection Act (Quebec), or any other similar provincial or federal legislation.

# INDEX

Anode .....	25	Dealer Locator Information .....	109
Replacement .....	78	Distributor's Limited Warranty .....	112
ARE YOU READY TO GET UNDERWAY?.....	34	Distributor's Warranty.....	122
ATTACHMENT .....	31		
		EMERGENCY STARTING.....	45
Battery .....	101	Emergency Stop Switch Clip and Emergency	
CONNECTIONS.....	32	Stop Switch .....	17
Terminals .....	33	Emission Control System Information .....	102
WILL NOT CHARGE.....	96	Emission Control System Warranty .....	117
BEFORE OPERATION.....	34	Engine	
BREAK-IN PROCEDURE .....	36	Cover	
		Latch .....	22
Carburetor Modification for High Altitude		REMOVAL AND INSTALLATION .....	63
Operation.....	101	Oil	
Choke Knob.....	17	Change .....	65
CLEANING AND FLUSHING.....	81	Level Check.....	64
COMPONENT AND CONTROL LOCATIONS .....	15	Recommendations .....	67
CONSUMER INFORMATION.....	109	ENGINE OVERHEATS .....	94
CONTROL AND FEATURE IDENTIFICATION		ENGINE WILL NOT DRIVE THE PROPELLER .....	95
CODES .....	14	ENGINE WILL NOT START.....	91
CONTROLS.....	17		
CONTROLS AND FEATURES .....	14		
Cooling System Indicator .....	25		
CRUISING.....	55		
Customer Service Information.....	110		

# INDEX

Fuel		IMPORTANT SAFETY INFORMATION .....	6
Filler Cap Vent Knob.....	21, 26	INDICATORS .....	24
Filter Inspection and Replacement .....	75	INFREQUENT OR OCCASIONAL USE .....	41
HOSE CONNECTIONS .....	40	INSTALLATION .....	30
Hose Connector Cap and Fuel Hose Connector (Male).....	26	INSTALLATION POSITION .....	30
PRIMING .....	40	IS YOUR OUTBOARD MOTOR READY TO GO? .....	34
Priming Bulb.....	27	Lubrication Points.....	69
RECOMMENDATIONS.....	74	MAINTENANCE SAFETY .....	59
Fuse		MAINTENANCE SCHEDULE .....	61
Replacement .....	96	MOORING, BEACHING, LAUNCHING.....	57
Gear Case Oil		Oil Pressure Indicator .....	24
Change.....	67	OIL PRESSURE INDICATOR GOES OFF AND ENGINE SPEED IS LIMITED .....	97
Gearshift Lever .....	19	OPERATION.....	36
GEARSHIFTING AND THROTTLE OPERATION ....	53	OTHER FEATURES.....	25
Handle Stopper .....	23	OUTBOARD MOTOR SAFETY.....	6
HARD STARTING OR STALLS AFTER STARTING.....	93		
Honda Publications.....	109		

# INDEX

Portable Fuel Tank .....	26, 39	STORAGE .....	84
Portable Fuel Tank and Tank Filter Cleaning .....	77	Engine Oil .....	86
POWER REQUIREMENTS .....	30	Fuel.....	84
Propeller and Shear Pin Replacement .....	79	STORAGE PRECAUTIONS.....	87
Recoil Starter Rope Inspection .....	78	SUBMERGED OUTBOARD MOTOR.....	98
REFUELING.....	71	TAKING CARE OF UNEXPECTED PROBLEMS ....	91
REMOVAL FROM STORAGE .....	88	TECHNICAL INFORMATION .....	100
Rev Limiter .....	25	THE IMPORTANCE OF MAINTENANCE.....	58
SAFE OPERATING PRECAUTIONS.....	36	Throttle Friction Knob .....	18
SAFETY LABEL LOCATIONS .....	8	Throttle Grip .....	18
Serial Number Locations .....	100	Tilt Lever .....	23
SERVICING YOUR OUTBOARD MOTOR .....	58	TOOL KIT AND EMERGENCY STARTER ROPE...	60
SHALLOW WATER OPERATION.....	56	Transom Angle Adjusting Rod.....	22
Spark Plug Service.....	70	TRANSOM ANGLE ADJUSTMENT.....	31, 37
Specifications .....	106, 107, 108	TRANSPORTING .....	89
Star Label .....	104	WITH OUTBOARD MOTOR INSTALLED ON	
Starter Grip.....	22	BOAT.....	89
STARTING THE ENGINE.....	41	WITH OUTBOARD MOTOR REMOVED FROM	
STEERING .....	54	BOAT.....	90
Steering Friction Bolt .....	23	Warranty Statements .....	112
STOPPING THE ENGINE .....	51		
Emergency Engine Stopping .....	51		
Normal Engine Stopping.....	51		

---

**MEMO**

# HONDA

31ZVC610  
00X31-ZVC-6100



XXXX.XXXX.XX  
Printed in China