

EB5000i Generator AC Receptacle Selection

Power Circuits

The EB5000i generator is equipped with two power circuits. The power available to each receptacle depends on the position of the voltage selector switch.

When the voltage selector switch is in the 120V/240V position, the power circuits operate in series, like two separate generators. Each circuit supplies up to 18.8 amps maximum to specific receptacles as shown in the graphic. Neither power circuit can supply power to the other power circuit's receptacles. It is important, therefore, to balance the load on both power circuits.

When the voltage selector switch is in the 120V ONLY position, the power circuits operate in parallel, sharing the total load connected to receptacles 1, 2, 3, and terminal 4A of receptacle 4. Since both power circuits share the total load, there is no need to balance the load.

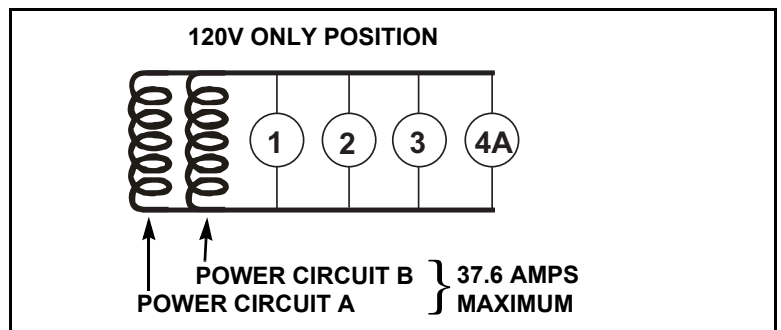
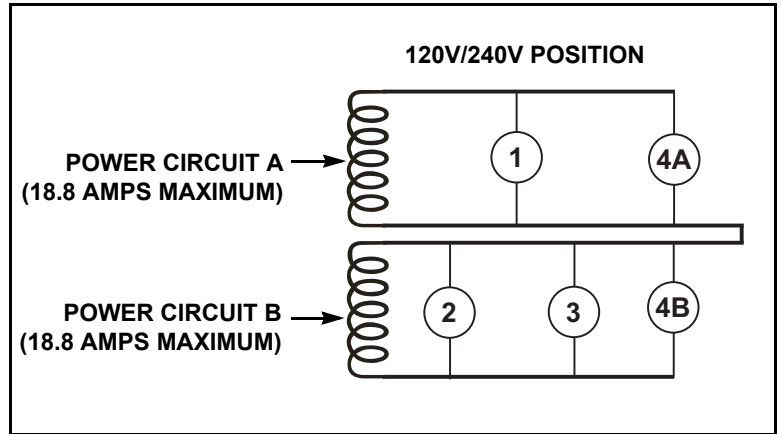

Control Panel

The control panel has a voltage selector switch and four receptacles.

Receptacle 1 is the top outlet on a 20A-120V duplex receptacle.

Receptacle 2 is the bottom outlet on a 20A-120V duplex receptacle.

Receptacle 3 is a 30A-120V locking receptacle.

Receptacle 4 is a 30A-120V/240V receptacle and has two powered terminals, 4A and 4B.

When the voltage selector switch is in the 120V/240V position, receptacle 4 supplies up to 18.8A at 240 volts from the combination of power circuits A and B.

When the voltage selector switch is in the 120V only position, terminal 4A supplies up to 30 amps at 120 volts from power circuits A and B; terminal 4B has no power.

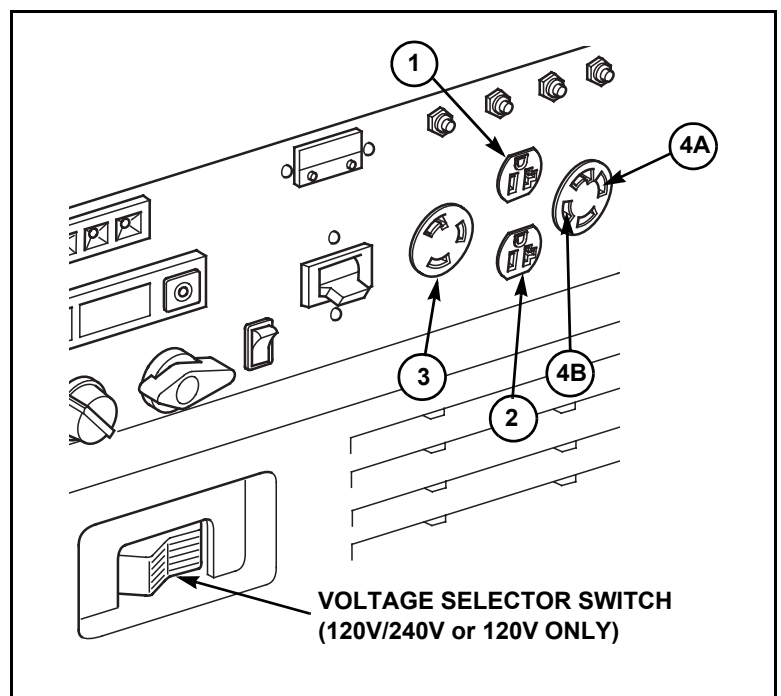

Voltage Selector Switch

Disconnect or turn off all appliances or tools connected to the generator before changing the voltage selector switch position. The generator may be damaged if the switch position is changed with loads connected and operating.

120V ONLY Position

When the voltage selector switch is in the 120V ONLY position, you do not need to spread the load over the receptacles. You must, however, make sure the load on any receptacle does not exceed its available power shown in the table and the total load does not exceed 37.6 amps.

Receptacle	Available Power	Total Current Available
1	20A at 120V	37.6A
2	20A at 120V	
3	30A at 120V	
4A	30A at 120V	
4B	None	

120V/240V Position

When the voltage selector switch is in the 120V/240V position, you must balance the load on both power circuits. Divide the load between the two sets of receptacles shown in the table. Do not exceed the current rating of any receptacle. Balancing is necessary because each set of receptacles is powered by only one power circuit that can produce a maximum of 18.8 amps.

Set of Receptacles	Total Current Available	Power Circuit
1 + 4A	18.8A at 120V	A
2 + 3 + 4B	18.8A at 120V	B
4A + 4B	18.8A at 240V	A + B

Overloading

The rated power of this generator is 4.5 kVA; maximum power is 5.0 kVA. Never exceed the maximum power rating of the generator. Power levels between rated and maximum may be used for no more than 30 minutes.