

How to Clean Miimo

Robotic Lawn Mower

Clean Miimo every week to keep it running at a high level of performance. Dirt and grass may build up on the top and bottom during mowing, or while parked in the docking station. Accumulation of dirt and grass can prevent Miimo from cutting the lawn to the best of its ability.

Follow the instructions below to keep Miimo clean and functioning properly. If you are not comfortable cleaning Miimo following the information below, contact an authorized Honda Power Equipment dealer for assistance. Visit powerequipment.honda.com to find a dealer near you, or call us at 770-497-6400, option 6.



Before Cleaning

⚠ WARNING

The blades are extremely sharp, and can cut you severely. Do not touch the blades with your hands. Put on a pair of work gloves before cleaning Miimo.

- Press the manual STOP button, turn Miimo OFF, and then remove Miimo from the docking station.
- Do not tilt Miimo beyond 90° from your work surface to avoid having grass or other debris enter inside the mower.

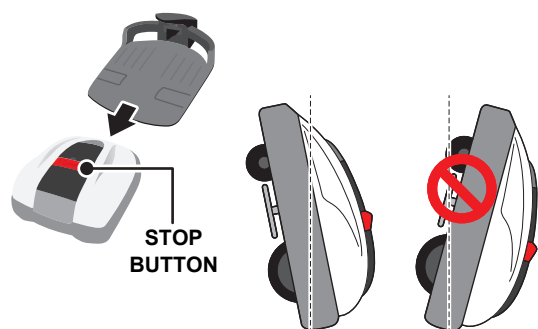

Cleaning the Exterior

Clean dirt and grass off of Miimo's body, charging socket, and control panel using a dry brush and a cloth. **Do not wash Miimo with water or use a garden hose to clean it.**

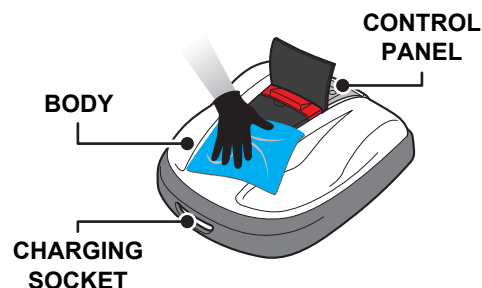

Cleaning Underneath Miimo

Using a dry brush or scraper, remove any grass clippings attached to the blades, blade disc, wheels, and water drain holes. Remember, do not tilt Miimo beyond an angle of 90°.

Never pour water on the bottom of Miimo, and avoid using a sponge or rag soaked with water. Miimo may be damaged if water or dirt, such as grass clippings, enter the inside of Miimo through the drain holes or gaps.

Using dry, compressed air will complement dry brush cleaning and may help dislodge stubborn dirt and grass clippings.

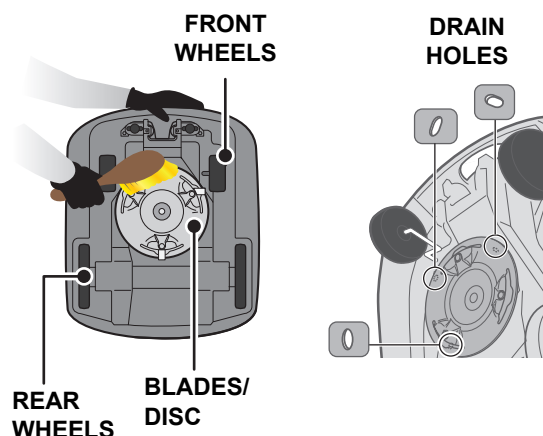

Cleaning the Docking Station

Unplug the transformer plug from the building's power outlet before cleaning the docking station.

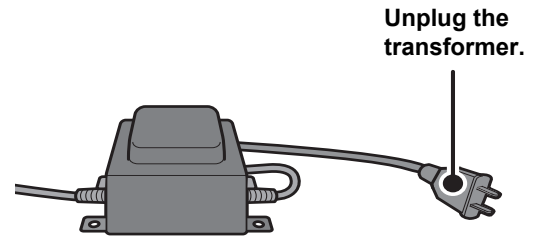

Clean the docking station using a brush. Remove dirt and grass from the docking station, particularly around the charging plug area and parts where Miimo rests.

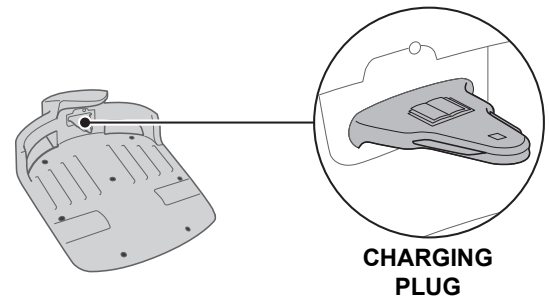

After Cleaning

After cleaning is complete, place Miimo back in the charging station.

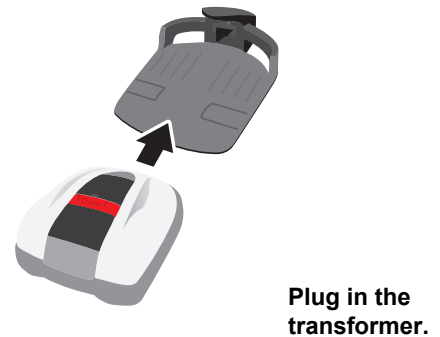

Reconnect the transformer plug to the building's power outlet.

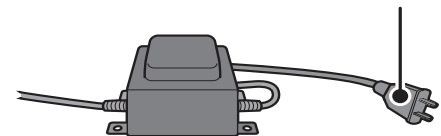

Turn Miimo ON, and then close the control panel cover.

